

DEWALT®

XR®

English

3

简体中文

13

Fig. A
图 A

DCF911

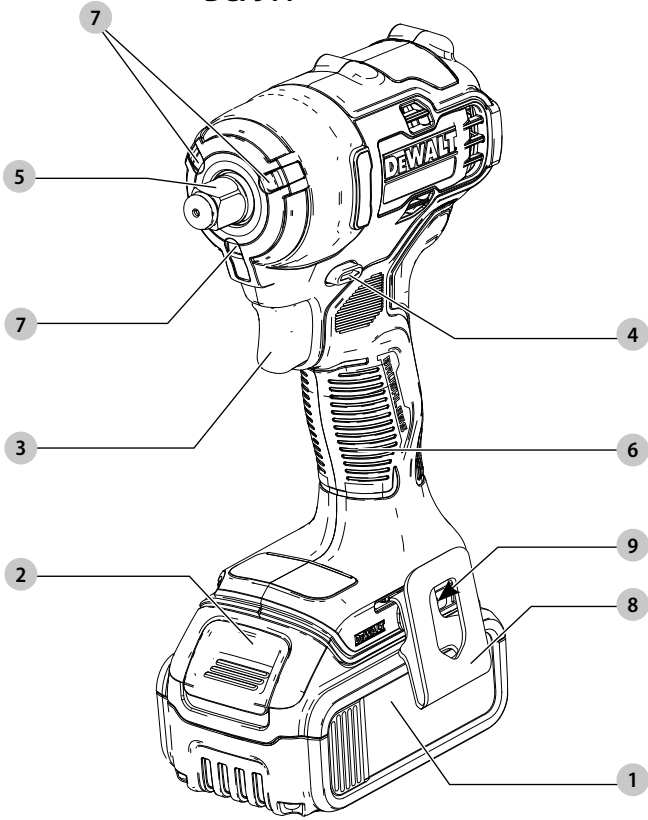

Fig. B
图 B

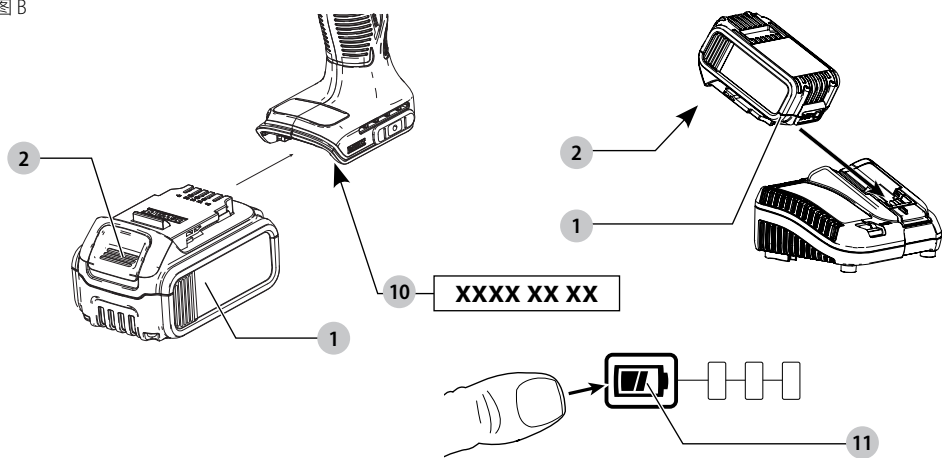

Fig. C
图 C

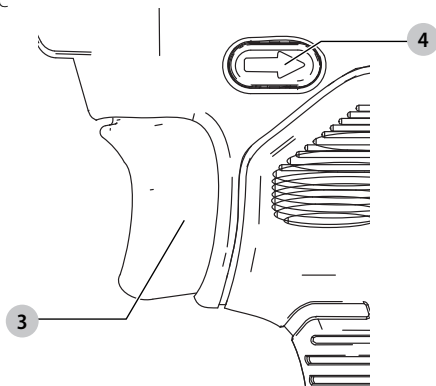

Fig. D
图 D

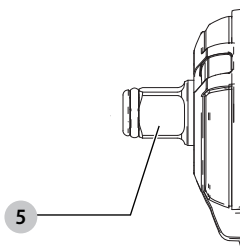
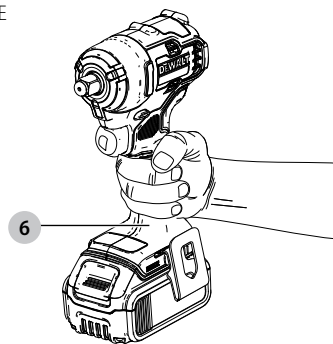

Fig. E
图 E



18V CORDLESS IMPACT WRENCH

DCF911

Congratulations!

You have chosen a DEWALT tool. Years of experience, thorough product development and innovation make DEWALT one of the most reliable partners for professional power tool users.

Technical Data

		DCF911
Voltage	V _{DC}	18(20V Max)
Battery type		Li-Ion
Power output	W	300
No load speed	min ⁻¹	0–2850
Impact rate	min ⁻¹	0–3250
Max tightening torque	Nm	338
Max breakaway torque	Nm	542
Tool holder	mm	12.7
Weight (without battery pack)	kg	1.0

Batteries				Chargers / Charge Times (Minutes)							
Cat#	V _{DC}	Ah	Weight(kg)	DCB104	DCB107	DCB112	DCB115	DCB117	DCB118	DCB132	DCB112
DCB546/DCB606	18/54 (20/60 Max)	6.0/2.0	1.08	60	270	170	90	40	60	90	40
DCB547/DCB609	18/54 (20/60 Max)	9.0/3.0	1.46	75*	420	270	135*	60	75*	135*	60
DCB548/DCB612	18/54 (20/60 Max)	12.0/4.0	1.46	120	540	350	180	80	120	180	80
DCB549/DCB615	18/54 (20/60 Max)	15.0/5.0	2.12	125	730	450	230	90	125	230	90
DCB181	18 (20 Max)	1.5	0.35	22	70	45	22	22	22	22	22
DCB182/DCB204	18 (20 Max)	4.0	0.61	60/40**	185	120	60	60/40**	60/40**	60	60/40**
DCB183/DCB203	18 (20 Max)	2.0	0.40	30	90	60	30	30	30	30	30
DCB184/DCB205	18 (20 Max)	5.0	0.62	75/50**	240	150	75	75/50**	75/50**	75	75/50**
DCB185	18 (20 Max)	1.3	0.35	22	60	40	22	22	22	22	22
DCB187	18 (20 Max)	3.0	0.54	45	140	90	45	45	45	45	45
DCB189/DCB240	18 (20 Max)	4.0	0.54	60	185	120	60	60	60	60	60
DCB186	18 (20 Max)	6.0	0.95	60	270	170	90	60	60	90	60
DCBP034	18 (20 Max)	1.7	0.32	27	82	50	27	27	27	27	27

*Date code 201811475B or later

**Date code 201536 or later



WARNING: Read all safety warnings and all instructions. Failure to follow the warnings and instructions may result in electric shock, fire and/or serious injury.



WARNING: To reduce the risk of injury, read the instruction manual.

Intended Use

This impact wrench is designed for professional impact fastening and drilling applications. The impact function makes this tool particularly useful for driving fasteners in wood, metal and concrete.

DO NOT use under wet conditions or in presence of flammable liquids or gases.

DO NOT let children come into contact with the tool. Supervision is required when inexperienced operators use this tool.

Definitions: Safety Alert Symbols and Words

This instruction manual uses the following safety alert symbols and words to alert you to hazardous situations and your risk of personal injury or property damage.



DANGER: Indicates an imminently hazardous situation which, if not avoided, **will** result in **death or serious injury**.



WARNING: Indicates a potentially hazardous situation which, if not avoided, **could** result in **death or serious injury**.



CAUTION: Indicates a potentially hazardous situation which, if not avoided, **may** result in **minor or moderate injury**.



(Used without word) Indicates a safety related message.

NOTICE: Indicates a practice **not related to personal injury** which, if not avoided, **may** result in **property damage**.

GENERAL POWER TOOL SAFETY WARNINGS



WARNING: Read all safety warnings, instructions, illustrations and specifications provided with this power tool. Failure to follow all instructions listed below may result in electric shock, fire and/or serious injury.

SAVE ALL WARNINGS AND INSTRUCTIONS FOR FUTURE REFERENCE.

The term "power tool" in the warnings refers to your mains-operated (corded) power tool or battery-operated (cordless) power tool.

1) Work Area Safety

- Keep work area clean and well lit.** Cluttered or dark areas invite accidents.
- Do not operate power tools in explosive atmospheres, such as in the presence of flammable liquids, gases or dust.** Power tools create sparks which may ignite the dust or fumes.

- Keep children and bystanders away while operating a power tool.** Distractions can cause you to lose control.

2) Electrical Safety

- Power tool plugs must match the outlet. Never modify the plug in any way. Do not use any adapter plugs with earthed (grounded) power tools.** Unmodified plugs and matching outlets will reduce risk of electric shock.
- Avoid body contact with earthed or grounded surfaces, such as pipes, radiators, ranges and refrigerators.** There is an increased risk of electric shock if your body is earthed or grounded.
- Do not expose power tools to rain or wet conditions.** Water entering a power tool will increase the risk of electric shock.
- Do not abuse the cord. Never use the cord for carrying, pulling or unplugging the power tool. Keep cord away from heat, oil, sharp edges or moving parts.** Damaged or entangled cords increase the risk of electric shock.
- When operating a power tool outdoors, use an extension cord suitable for outdoor use.** Use of a cord suitable for outdoor use reduces the risk of electric shock.
- If operating a power tool in a damp location is unavoidable, use a ground fault circuit interrupter (GFCI) protected supply.** Use of a GFCI reduces the risk of electric shock.

3) Personal Safety

- Stay alert, watch what you are doing and use common sense when operating a power tool. Do not use a power tool while you are tired or under the influence of drugs, alcohol or medication.** A moment of inattention while operating power tools may result in serious personal injury.
- Use personal protective equipment. Always wear eye protection.** Protective equipment such as a dust mask, non-skid safety shoes, hard hat, or hearing protection used for appropriate conditions will reduce personal injuries.
- Prevent unintentional starting. Ensure the switch is in the off-position before connecting to power source and/or battery pack, picking up or carrying the tool.** Carrying power tools with your finger on the switch or energizing power tools that have the switch on invites accidents.
- Remove any adjusting key or wrench before turning the power tool on.** A wrench or a key left attached to a rotating part of the power tool may result in personal injury.
- Do not overreach. Keep proper footing and balance at all times.** This enables better control of the power tool in unexpected situations.
- Dress properly. Do not wear loose clothing or jewelry. Keep your hair, clothing and gloves away from moving parts.** Loose clothes, jewelry or long hair can be caught in moving parts.

- g) **If devices are provided for the connection of dust extraction and collection facilities, ensure these are connected and properly used.** Use of dust collection can reduce dust-related hazards.
- h) **Do not let familiarity gained from frequent use of tools allow you to become complacent and ignore tool safety principles.** A careless action can cause severe injury within a fraction of a second.

4) Power Tool Use and Care

- a) **Do not force the power tool. Use the correct power tool for your application.** The correct power tool will do the job better and safer at the rate for which it was designed.
- b) **Do not use the power tool if the switch does not turn it on and off.** Any power tool that cannot be controlled with the switch is dangerous and must be repaired.
- c) **Disconnect the plug from the power source and/or remove the battery pack, if detachable, from the power tool before making any adjustments, changing accessories, or storing power tools.** Such preventive safety measures reduce the risk of starting the power tool accidentally.
- d) **Store idle power tools out of the reach of children and do not allow persons unfamiliar with the power tool or these instructions to operate the power tool.** Power tools are dangerous in the hands of untrained users.
- e) **Maintain power tools and accessories. Check for misalignment or binding of moving parts, breakage of parts and any other condition that may affect the power tool's operation. If damaged, have the power tool repaired before use.** Many accidents are caused by poorly maintained power tools.
- f) **Keep cutting tools sharp and clean.** Properly maintained cutting tools with sharp cutting edges are less likely to bind and are easier to control.
- g) **Use the power tool, accessories and tool bits etc. in accordance with these instructions, taking into account the working conditions and the work to be performed.** Use of the power tool for operations different from those intended could result in a hazardous situation.
- h) **Keep handles and grasping surfaces dry, clean and free from oil and grease.** Slippery handles and grasping surfaces do not allow for safe handling and control of the tool in unexpected situations.

5) Battery Tool Use and Care

- a) **Recharge only with the charger specified by the manufacturer.** A charger that is suitable for one type of battery pack may create a risk of fire when used with another battery pack.
- b) **Use power tools only with specifically designated battery packs.** Use of any other battery packs may create a risk of injury and fire.
- c) **When battery pack is not in use, keep it away from other metal objects, like paper clips, coins, keys, nails, screws or other small metal objects,**

that can make a connection from one terminal to another. Shorting the battery terminals together may cause burns or a fire.

- d) **Under abusive conditions, liquid may be ejected from the battery; avoid contact. If contact accidentally occurs, flush with water. If liquid contacts eyes, additionally seek medical help.** Liquid ejected from the battery may cause irritation or burns.
- e) **Do not use a battery pack or tool that is damaged or modified.** Damaged or modified batteries may exhibit unpredictable behavior resulting in fire, explosion or risk of injury.
- f) **Do not expose a battery pack or tool to fire or excessive temperature.** Exposure to fire or temperature above 265 °F (130 °C) may cause explosion.
- g) **Follow all charging instructions and do not charge the battery pack or tool outside the temperature range specified in the instructions.** Charging improperly or at temperatures outside the specified range may damage the battery and increase the risk of fire.

6) Service

- a) **Have your power tool serviced by a qualified repair person using only identical replacement parts.** This will ensure that the safety of the power tool is maintained.
- b) **Never service damaged battery packs.** Service of battery packs should only be performed by the manufacturer or authorized service providers.

Impact Wrench Safety Warnings - All Operations

- **Hold the power tool by insulated gripping surfaces, when performing an operation where the fastener may contact hidden wiring.** Fasteners contacting a "live" wire may make exposed metal parts of the power tool "live" and could give the operator an electric shock.
- **Wear ear protectors during use.** Exposure to noise can cause hearing loss.



WARNING: Impact wrenches are not torque wrenches. DO NOT use this tool for tightening fasteners to specified torques. An independent, calibrated torque measurement device such as a torque wrench should be used when under tightened or over tightened fasteners can lead to the failure of the joint.

Chargers

DEWALT chargers require no adjustment and are designed to be as easy as possible to operate.

Electrical Safety

The electric motor has been designed for one voltage only. Always check that the battery pack voltage corresponds to the voltage on the rating plate. Also make sure that the voltage of your charger corresponds to that of your mains.



Your DEWALT charger is double insulated in accordance with IEC60335; therefore no earth wire is required.

If the supply cord is damaged, it must be replaced only by DEWALT or an authorised service organisation.

Using an Extension Cable

An extension cord should not be used unless absolutely necessary. Use an approved extension cable suitable for the power input of your charger (see **Technical Data**). The minimum conductor size is 1 mm²; the maximum length is 30 m.

When using a cable reel, always unwind the cable completely.

- **Wear safety goggles or other eye protection. Hammering and drilling operations cause chips to fly.** Flying particles can cause permanent eye damage.
- **Do not operate this tool for long periods of time. Vibration caused by tool action may be harmful to your hands and arms.** Use gloves to provide extra cushion and limit exposure by taking frequent rest periods.
- **Accessories and tools get hot during operation.** Wear gloves when touching them.

Important Safety Instructions for All Battery Chargers

SAVE THESE INSTRUCTIONS: This manual contains important safety and operating instructions for compatible battery chargers (refer to **Technical Data**).

- Before using charger, read all instructions and cautionary markings on charger, battery pack, and product using battery pack.



WARNING: Shock hazard. Do not allow any liquid to get inside charger. Electric shock may result.



WARNING: We recommend the use of a residual current device with a residual current rating of 30mA or less.



CAUTION: Burn hazard. To reduce the risk of injury, charge only DEWALT rechargeable batteries. Other types of batteries may burst causing personal injury and damage.



CAUTION: Children should be supervised to ensure that they do not play with the appliance.

NOTICE: Under certain conditions, with the charger plugged into the power supply, the exposed charging contacts inside the charger can be shorted by foreign material. Foreign materials of a conductive nature such as, but not limited to, steel wool, aluminum foil or any buildup of metallic particles should be kept away from charger cavities. Always unplug the charger from the power supply when there is no battery pack in the cavity. Unplug charger before attempting to clean.

- **DO NOT attempt to charge the battery pack with any chargers other than the ones in this manual.** The charger and battery pack are specifically designed to work together.
- **These chargers are not intended for any uses other than charging DEWALT rechargeable batteries.**

Any other uses may result in risk of fire, electric shock or electrocution.

- **Do not expose charger to rain or snow.**
- **Pull by plug rather than cord when disconnecting charger.** This will reduce risk of damage to electric plug and cord.
- **Make sure that cord is located so that it will not be stepped on, tripped over, or otherwise subjected to damage or stress.**
- **Do not use an extension cord unless it is absolutely necessary.** Use of improper extension cord could result in risk of fire, electric shock, or electrocution.
- **Do not place any object on top of charger or place the charger on a soft surface that might block the ventilation slots and result in excessive internal heat.** Place the charger in a position away from any heat source. The charger is ventilated through slots in the top and the bottom of the housing.
- **Do not operate charger with damaged cord or plug—** have them replaced immediately.
- **Do not operate charger if it has received a sharp blow, been dropped, or otherwise damaged in any way.** Take it to an authorised service centre.
- **Do not disassemble charger; take it to an authorised service centre when service or repair is required.** Incorrect reassembly may result in a risk of electric shock, electrocution or fire.
- **In case of damaged power supply cord, the supply cord must be replaced immediately by the manufacturer, its service agent or similar qualified person to prevent any hazard.**
- **Disconnect the charger from the outlet before attempting any cleaning. This will reduce the risk of electric shock.** Removing the battery pack will not reduce this risk.
- **NEVER attempt to connect two chargers together.**
- **The charger is designed to operate on standard 220-240V household electrical power. Do not attempt to use it on any other voltage.** This does not apply to the vehicular charger.





Charging a Battery (Fig. B)

1. Plug the charger into an appropriate outlet before inserting battery pack.
2. Insert the battery pack ① into the charger, making sure the battery pack is fully seated in the charger. The red (charging) light will blink repeatedly indicating that the charging process has started.
3. The completion of charge will be indicated by the red light remaining ON continuously. The battery pack is fully charged and may be used at this time or left in the charger. To remove the battery pack from the charger, push the battery release button ② on the battery pack.

NOTE: To ensure maximum performance and life of lithium-ion battery packs, charge the battery pack fully before first use.

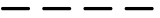
Charger Operation

Refer to the indicators below for the charge status of the battery pack.

Charge Indicators		
	Charging	
	Fully Charged	
	Hot/Cold Pack Delay*	

*The red light will continue to blink, but a yellow indicator light will be illuminated during this operation. Once the battery pack has reached an appropriate temperature, the yellow light will turn off and the charger will resume the charging procedure.

The compatible charger(s) will not charge a faulty battery pack. The charger will indicate faulty battery by refusing to light.

NOTE: This could also mean a problem with a charger. If the charger indicates a problem, take the charger and battery pack to be tested at an authorised service centre.

Hot/Cold Pack Delay

When the charger detects a battery pack that is too hot or too cold, it automatically starts a Hot/Cold Pack Delay, suspending charging until the battery pack has reached an appropriate temperature. The charger then automatically switches to the pack charging mode. This feature ensures maximum battery pack life.

A cold battery pack will charge at a slower rate than a warm battery pack. The battery pack will charge at that slower rate throughout the entire charging cycle and will not return to maximum charge rate even if the battery pack warms.

The DCB118 charger is equipped with an internal fan designed to cool the battery pack. The fan will turn on automatically when the battery pack needs to be cooled. Never operate the charger if the fan does not operate properly or if ventilation slots are blocked. Do not permit foreign objects to enter the interior of the charger.

Electronic Protection System

XR Li-Ion tools are designed with an Electronic Protection System that will protect the battery pack against overloading, overheating or deep discharge.

The tool will automatically turn off if the Electronic Protection System engages. If this occurs, place the lithium-ion battery pack on the charger until it is fully charged.

Wall Mounting

These chargers are designed to be wall mountable or to sit upright on a table or work surface. If wall mounting, locate the charger within reach of an electrical outlet, and away from a corner or other obstructions which may impede air flow. Use the back of the charger as a template for the location of the mounting screws on the wall. Mount the charger securely using drywall screws (purchased separately) at least 25.4 mm long with a screw head diameter of 7–9 mm, screwed into wood to an optimal depth leaving approximately 5.5 mm of the screw exposed. Align the slots

on the back of the charger with the exposed screws and fully engage them in the slots.

Charger Cleaning Instructions

WARNING: Shock hazard. Disconnect the charger from the AC outlet before cleaning. Dirt and grease may be removed from the exterior of the charger using a cloth or soft non-metallic brush. Do not use water or any cleaning solutions. Never let any liquid get inside the tool; never immerse any part of the tool into a liquid.

Battery Packs

Important Safety Instructions for All Battery Packs

When ordering replacement battery packs, be sure to include catalogue number and voltage.

The battery pack is not fully charged out of the carton. Before using the battery pack and charger, read the safety instructions below. Then follow charging procedures outlined.

READ ALL INSTRUCTIONS

- **Do not charge or use battery in explosive atmospheres, such as in the presence of flammable liquids, gases or dust.** Inserting or removing the battery from the charger may ignite the dust or fumes.
- **Never force battery pack into charger. Do not modify battery pack in any way to fit into a non-compatible charger as battery pack may rupture causing serious personal injury.**
- Charge the battery packs only in DeWALT chargers.
- **DO NOT splash or immerse in water or other liquids.**
- **Do not store or use the tool and battery pack in locations where the temperature may fall below 4 °C (39.2 °F) (such as outside sheds or metal buildings in winter), or reach or exceed 40 °C (104 °F) (such as outside sheds or metal buildings in summer).**
- **Do not incinerate the battery pack even if it is severely damaged or is completely worn out.** The battery pack can explode in a fire. Toxic fumes and materials are created when lithium-ion battery packs are burned.
- **If battery contents come into contact with the skin, immediately wash area with mild soap and water.** If battery liquid gets into the eye, rinse water over the open eye for 15 minutes or until irritation ceases. If medical attention is needed, the battery electrolyte is composed of a mixture of liquid organic carbonates and lithium salts.
- **Contents of opened battery cells may cause respiratory irritation.** Provide fresh air. If symptoms persists, seek medical attention.

WARNING: Burn hazard. Battery liquid may be flammable if exposed to spark or flame.

WARNING: Never attempt to open the battery pack for any reason. If battery pack case is cracked or damaged, do not insert into charger. Do not crush, drop or damage battery pack. Do not use a battery pack or

charger that has received a sharp blow, been dropped, run over or damaged in any way (i.e., pierced with a nail, hit with a hammer, stepped on). Electric shock or electrocution may result. Damaged battery packs should be returned to service centre for recycling.



WARNING: Fire hazard. Do not store or carry the battery pack so that metal objects can contact exposed battery terminals. For example, do not place the battery pack in aprons, pockets, tool boxes, product kit boxes, drawers, etc., with loose nails, screws, keys, etc.



CAUTION: When not in use, place tool on its side on a stable surface where it will not cause a tripping or falling hazard. Some tools with large battery packs will stand upright on the battery pack but may be easily knocked over.

Transportation



WARNING: Fire hazard. Transporting batteries can possibly cause fire if the battery terminals inadvertently come in contact with conductive materials. When transporting batteries, make sure that the battery terminals are protected and well insulated from materials that could contact them and cause a short circuit. **NOTE:** Lithium-ion batteries should not be put in checked baggage.

DEWALT batteries comply with all applicable shipping regulations as prescribed by industry and legal standards which include UN Recommendations on the Transport of Dangerous Goods; International Air Transport Association (IATA) Dangerous Goods Regulations, International Maritime Dangerous Goods (IMDG) Regulations, and the European Agreement Concerning The International Carriage of Dangerous Goods by Road (ADR). Lithium-ion cells and batteries have been tested to section 38.3 of the UN Recommendations on the Transport of Dangerous Goods Manual of Tests and Criteria.

In most instances, shipping a DEWALT battery pack will be excepted from being classified as a fully regulated Class 9 Hazardous Material. In general, only shipments containing a lithium-ion battery with an energy rating greater than 100 Watt Hours (Wh) will require being shipped as fully regulated Class 9. All lithium-ion batteries have the Watt Hour rating marked on the pack. Furthermore, due to regulation complexities, DEWALT does not recommend air shipping lithium-ion battery packs alone regardless of Watt Hour rating. Shipments of tools with batteries (combo kits) can be air shipped as excepted if the Watt Hour rating of the battery pack is no greater than 100 Wh.

Regardless of whether a shipment is considered excepted or fully regulated, it is the shipper's responsibility to consult the latest regulations for packaging, labeling/marketing and documentation requirements.

The information provided in this section of the manual is provided in good faith and believed to be accurate at the time the document was created. However, no warranty, expressed or implied, is given. It is the buyer's

responsibility to ensure that its activities comply with the applicable regulations.

Transporting the FLEXVOLT™ Battery

The DEWALT FLEXVOLT™ battery has two modes: **Use** and **Transport**.

Use Mode: When the FLEXVOLT™ battery stands alone or is in a DEWALT 18V (20V Max) product, it will operate as an 18V (20V Max) battery. When the FLEXVOLT™ battery is in a 54V (60V Max) or a 108V (120V Max) (two 54V (60V Max) batteries) product, it will operate as a 54V (60V Max) battery.

Transport Mode: When the cap is attached to the FLEXVOLT™ battery, the battery is in Transport mode. Keep the cap for shipping.

When in Transport mode, strings of cells are electrically disconnected within the pack resulting in 3 batteries with a lower Watt hour (Wh) rating as compared to 1 battery with a higher Watt hour rating. This increased quantity of 3 batteries with the lower Watt hour rating can exempt the pack from certain shipping regulations that are imposed upon the higher Watt hour batteries.

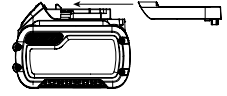

For example, the Transport Wh rating might indicate 3 x 36 Wh, meaning

Example of Use and Transport Label Marking



3 batteries of 36 Wh each. The Use Wh rating might indicate 108 Wh (1 battery implied).

Storage Recommendations

1. The best storage place is one that is cool and dry away from direct sunlight and excess heat or cold. For optimum battery performance and life, store battery packs at room temperature when not in use.
2. For long storage, it is recommended to store a fully charged battery pack in a cool, dry place out of the charger for optimal results.

NOTE: Battery packs should not be stored completely depleted of charge. The battery pack will need to be recharged before use.

Labels on Charger and Battery Pack

In addition to the pictographs used in this manual, the labels on the charger and the battery pack may show the following pictographs:



Read instruction manual before use.



See **Technical Data** for charging time.



Do not probe with conductive objects.



Do not charge damaged battery packs.



Do not expose to water.



Have defective cords replaced immediately



Charge only between 4 °C and 40 °C.



Only for indoor use.



Discard the battery pack with due care for the environment.



Charge DEWALT battery packs only with designated DEWALT chargers. Charging battery packs other than the designated DEWALT batteries with a DEWALT charger may make them burst or lead to other dangerous situations.



Do not incinerate the battery pack.



USE (without transport cap). Example: Wh rating indicates 108 Wh (1 battery with 108 Wh).



TRANSPORT (with built-in transport cap). Example: Wh rating indicates 3 x 36 Wh (3 batteries of 36 Wh).

Battery Type

The following tools operate on an 18(20V Max) volt battery pack: DCF911.

These battery packs may be used: DCB181, DCB182, DCB183, DCB184, DCB185, DCB187, DCB189, DCB203, DCB204, DCB205, DCB546, DCB547, DCB548, DCB606, DCB609, DCB612, DCBP034. Refer to **Technical Data** for more information.

Package Contents

The package contains:

- 1 Impact wrench
- 1 Charger (Except DCF911N)
- 1 Belt hook
- 1 Li-Ion battery pack (C1, D1, E1, L1, M1, P1, S1, T1, X1, Y1 models)
- 2 Li-Ion battery packs (C2, D2, E2, L2, M2, P2, S2, T2, X2, Y2 models)
- 3 Li-Ion battery packs (C3, D3, E3, L3, M3, P3, S3, T3, X3, Y3 models)
- 1 Instruction manual

Markings on Tool

The following pictograms are shown on the tool:



Read instruction manual before use.



Wear ear protection.



Wear eye protection.



Visible radiation. Do not stare into light.

Date Code Position (Fig. B)

The date code **10**, which also includes the year of manufacture, is printed into the housing.

Example:

2021 XX XX

Year and Week of Manufacture

Description (Fig. A, B)



WARNING: Never modify the power tool or any part of it. Damage or personal injury could result.

- 1 Battery pack
- 2 Battery release button
- 3 Trigger switch
- 4 Forward/reverse control button
- 5 Anvil
- 6 Main Handle
- 7 Worklight
- 8 Belt hook
- 9 Screw

Intended Use

These impact wrenches are designed for professional impact fastening applications. The impact function makes this tool particularly useful for driving fasteners in wood, metal and concrete.

DO NOT use under wet conditions or in the presence of flammable liquids or gases.

These impact wrenches are professional power tools.

DO NOT let children come into contact with the tool. Supervision is required when inexperienced operators use this tool.

- **Young children and the infirm.** This appliance is not intended for use by young children or infirm persons without supervision.
- This product is not intended for use by persons (including children) suffering from diminished physical, sensory or mental abilities; lack of experience, knowledge or skills unless they are supervised by a person responsible for their safety. Children should never be left alone with this product.

ASSEMBLY AND ADJUSTMENTS



WARNING: To reduce the risk of serious personal injury, turn tool off and disconnect battery pack before making any adjustments or removing/installing attachments or accessories. An accidental start-up can cause injury.



WARNING: Use only DEWALT battery packs and chargers.

Inserting and Removing the Battery Pack from the Tool (Fig. B)

NOTE: Make sure your battery pack **1** is fully charged.

To Install the Battery Pack into the Tool Handle

1. Align the battery pack ① with the rails inside the tool's handle (Fig. B).
2. Slide it into the handle until the battery pack is firmly seated in the tool and ensure that you hear the lock snap into place.

To Remove the Battery Pack from the Tool

1. Press the release button ② and firmly pull the battery pack out of the tool handle.
2. Insert battery pack into the charger as described in the charger section of this manual.

Fuel Gauge Battery Packs (Fig. B)

Some DEWALT battery packs include a fuel gauge which consists of three green LED lights that indicate the level of charge remaining in the battery pack.

To actuate the fuel gauge, press and hold the fuel gauge button ①①. A combination of the three green LED lights will illuminate designating the level of charge left. When the level of charge in the battery is below the usable limit, the fuel gauge will not illuminate and the battery will need to be recharged.

NOTE: The fuel gauge is only an indication of the charge left on the battery pack. It does not indicate tool functionality and is subject to variation based on product components, temperature and end-user application.

Belt Hook (Fig. A)

 **WARNING:** To reduce the risk of serious personal injury, turn tool off and disconnect battery pack before making any adjustments or removing/installing attachments or accessories.

 **WARNING:** To reduce the risk of serious personal injury, DO NOT suspend tool overhead or suspend objects from the belt hook. ONLY hang tool's belt hook from a work belt.

 **WARNING:** To reduce the risk of serious personal injury, ensure the screw holding the belt hook is secure.

 **CAUTION:** To reduce the risk of personal injury or damage, DO NOT use the belt hook to hang the drill while using as a spotlight.

IMPORTANT: When attaching or replacing the belt hook, use only the screw ⑨ that is provided. Be sure to securely tighten the screw.

The belt hook ⑧ can be attached to either side of the tool using only the screw ⑨ provided, to accommodate left- or right-handed users. If the hook is not desired at all, it can be removed from the tool.

To move belt hook, remove the screw ⑨ that holds it in place then reassemble on the opposite side. Be sure to securely tighten the screw.

Variable Speed Trigger and Forward/Reverse Control Button (Fig. C)

The tool is turned on and off by pulling and releasing the variable speed trigger ③. The farther the trigger is depressed, the higher the speed of the tool. Your tool is equipped with a brake. The chuck will stop as soon as the trigger switch is fully released.

A forward/reverse control button ④ determines the rotational direction of the tool and also serves as a lock-off button.

- To select forward rotation (clockwise), release the trigger and depress the forward/reverse control button on the right side of the tool.
- To select reverse (counterclockwise), depress the forward/reverse control button on the left side of the tool.

NOTE: The center position of the control button locks the tool in the off position. When changing the position of the control button, be sure the trigger is released.

NOTE: Continuous use in variable speed range is not recommended. It may damage the switch and should be avoided.

NOTE: The first time the tool is run after changing the direction of rotation, you may hear a click on start up. This is normal and does not indicate a problem.

Worklight (Fig. A)

The worklight ⑦ is activated when the trigger switch is depressed, and will automatically turn off 20 seconds after the trigger switch is released. If the trigger switch remains depressed, the worklight will remain on.

NOTE: The worklight is for lighting the immediate work surface and is not intended to be used as a flashlight.

Anvil (Fig. A,D)

 **WARNING:** Use only impact accessories. Non-impact accessories may break and cause a hazardous condition. Inspect accessory prior to use to ensure that it contains no cracks.

 **CAUTION:** Inspect anvils, detent pins, and hog rings prior to use. Missing or damaged items should be replaced before use.

Place the switch in the locked off (centre) position or remove battery pack before changing accessories.

To install an accessory on the hog ring anvil, firmly push accessory onto the anvil ⑤. The hog ring compresses to allow the accessory to slide on. After accessory is installed, the hog ring applies pressure to help provide accessory retention.

To remove an accessory, grasp the accessory and firmly pull it off.

OPERATION

Instructions for Use

 **WARNING:** Always observe the safety instructions and applicable regulations.

 **WARNING:** To reduce the risk of serious personal injury, turn tool off and disconnect battery pack before making any adjustments or removing/installing attachments or accessories. An accidental start-up can cause injury.



Lubrication

Your power tool requires no additional lubrication.

Proper Hand Position (Fig. E)

 **WARNING:** To reduce the risk of serious personal injury, ALWAYS use proper hand position as shown.

 **WARNING:** To reduce the risk of serious personal injury, ALWAYS hold securely in anticipation of a sudden reaction.

Proper hand position requires one hand on the main handle **6**.

Usage (Fig. A)

 **CAUTION:** Ensure fastener and/or system will withstand the level of torque generated by the tool. Excessive torque may cause breakage and possible personal injury.

- Place the accessory on the fastener head. Keep the tool pointed straight at the fastener.
- Press variable speed trigger switch **3** to start operation. Release variable speed trigger switch to stop operation. Always check torque with a torque wrench, as the fastening torque is affected by many factors including the following:
 - Voltage:** Low voltage, due to a nearly discharged battery, will reduce fastening torque.
 - Accessory size:** Failure to use the correct accessory size will cause a reduction in fastening torque.
 - Bolt size:** Larger bolt diameters generally require higher fastening torque. Fastening torque will also vary according to length, grade, and torque coefficient.
 - Bolt:** Ensure that all threads are free of rust and other debris to allow proper fastening torque.
 - Material:** The type of material and surface finish of the material will affect fastening torque.
 - Fastening time:** Longer fastening time results in increased fastening torque. Using a longer fastening time than recommended could cause the fasteners to be overstressed, stripped or damaged.

MAINTENANCE

Your power tool has been designed to operate over a long period of time with a minimum of maintenance. Continuous satisfactory operation depends upon proper tool care and regular cleaning.

 **WARNING:** To reduce the risk of serious personal injury, turn tool off and disconnect battery pack before making any adjustments or removing/installing attachments or accessories. An accidental start-up can cause injury.

The charger and battery pack are not serviceable.



Cleaning

 **WARNING:** Blow dirt and dust out of the main housing with dry air as often as dirt is seen collecting in and around the air vents. Wear approved eye protection and approved dust mask when performing this procedure.

 **WARNING:** Never use solvents or other harsh chemicals for cleaning the non-metallic parts of the tool. These chemicals may weaken the materials used in these parts. Use a cloth dampened only with water and mild soap. Never let any liquid get inside the tool; never immerse any part of the tool into a liquid.

Optional Accessories

 **WARNING:** Since accessories, other than those offered by DEWALT, have not been tested with this product, use of such accessories with this tool could be hazardous. To reduce the risk of injury, only DEWALT recommended accessories should be used with this product.

Consult your dealer for further information on the appropriate accessories.

Protecting the Environment



Separate collection. Products and batteries marked with this symbol must not be disposed of with normal household waste.

 Products and batteries contain materials that can be recovered or recycled reducing the demand for raw materials. Please recycle electrical products and batteries according to local provisions. Further information is available at www.2helpU.com.

Rechargeable Battery Pack

This long life battery pack must be recharged when it fails to produce sufficient power on jobs which were easily done before. At the end of its technical life, discard it with due care for our environment:

- Run the battery pack down completely, then remove it from the tool.
- Li-Ion cells are recyclable. Take them to your dealer or a local recycling station. The collected battery packs will be recycled or disposed of properly.

After Service and Repair

- DEWALT service centers are staffed with trained personnel to provide customers with efficient and reliable product service.
- We do not take any responsibility when you have repaired in unauthorized service center. You can refer to the leaflet of CONTACT CENTER LOCATOR in product package and contact us through hotline, website or social media to find the nearest DEWALT service center around you.

冲击扳手

DCF911

恭喜!

感谢您选购 DeWALT 工具。凭借多年的产品开发和创新能力, DeWALT 已经成为专业电动工具用户最可靠的合作伙伴之一。

技术参数

		DCF911
电压	V _{DC}	18 伏(最大 20 伏)
电池类型		锂离子
功率输出	瓦	300
空载转速	转/分	0-2850
冲击频率	转/分	0-3250
最大紧固扭矩	牛米	338
最大拆卸扭矩	牛米	542
夹头尺寸	毫米	12.7
重量(不含电池组)	千克	1.0

电池				充电器/充电时间(分钟)							
型号	电压	安时	重量 (千克)	DCB104	DCB107	DCB112	DCB115	DCB117	DCB118	DCB132	DCB1112
DCB546/DCB606	18/54(最大 20/60)	6.0/2.0	1.08	60	270	170	90	40	60	90	40
DCB547/DCB609	18/54(最大 20/60)	9.0/3.0	1.46	75*	420	270	135*	60	75*	135*	60
DCB548/DCB612	18/54(最大 20/60)	12.0/4.0	1.46	120	540	350	180	80	120	180	80
DCB549/DCB615	18/54(最大 20/60)	15.0/5.0	2.12	125	730	450	230	90	125	230	90
DCB181	18(最大 20)	1.5	0.35	22	70	45	22	22	22	22	22
DCB182/DCB204	18(最大 20)	4.0	0.61	60/40**	185	120	60	60/40**	60/40**	60	60/40**
DCB183/DCB203	18(最大 20)	2.0	0.40	30	90	60	30	30	30	30	30
DCB184/DCB205	18(最大 20)	5.0	0.62	75/50**	240	150	75	75/50**	75/50**	75	75/50**
DCB185	18(最大 20)	1.3	0.35	22	60	40	22	22	22	22	22
DCB187	18(最大 20)	3.0	0.54	45	140	90	45	45	45	45	45
DCB189/DCB240	18(最大 20)	4.0	0.54	60	185	120	60	60	60	60	60
DCB186	18(最大 20)	6.0	0.95	60	270	170	90	60	60	90	60
DCBP034	18(最大 20)	1.7	0.32	27	82	50	27	27	27	27	27

*日期代码 201811475B 或更高版本

**日期代码 201536 或更高版本



警告:请仔细阅读所有安全警告和说明。如未遵守警告和说明,可能会导致触电、火灾和/或严重伤害。



警告:为降低伤害风险,请阅读使用手册。

设计用途

本冲击扳手设计用于专业冲击锁紧和钻孔用途。冲击功能使这个工具非常有用,特别是在木材、金属和混凝土中钻紧固件这方面。

请勿在潮湿或存在易燃液体、气体的环境中使用本工具。

请勿让儿童接触工具。缺乏经验的操作员需要在监督下使用本工具。

定义:安全警示标志和警示词

本使用手册使用以下安全警示标志和警示词来提醒您危险情况以及您面临的人身伤害和财产损失风险。



危险:表示存在紧急危险情况,如果不加以避免,将导致死亡或严重伤害。



警告:表示存在潜在的危險情况,如果不加以避免,可能导致死亡或严重伤害。



警示:表示存在潜在危險情况,如果不加以避免,可能导致轻度或中度伤害。



(不使用单词)表示安全相关消息。

注意:表示存在不涉及人身伤害的情况,如果不加以避免,可能导致财产损失。

电动工具通用安全警告



警告!阅读随电动工具提供的所有安全警告、说明、图示和规定。不遵照以下所列说明会导致电击、着火和/或严重伤害。

保存所有警告和说明书以备查阅。

警告中的术语“电动工具”指市电驱动(有线)电动工具或电池驱动(无线)电动工具。

a) 工作场地的安全

- 1) 保持工作场地清洁和明亮。杂乱和黑暗的场地会引发事故。
- 2) 不要在易爆环境,如有易燃液体、气体或粉尘的环境下操作电动工具。电动工具产生的火花会点燃粉尘或气体。
- 3) 操作电动工具时,远离儿童和旁观者。注意力不集中会使你失去对工具的控制。

b) 电气安全

- 1) 电动工具插头必须与插座相配。绝不能以任何方式改装插头。需接地的电动工具不能使用任何转换插头。未经改装的插头和相配的插座将降低电击风险。
- 2) 避免人体接触接地表面,如管道、散热片和冰箱。如果你身体接触接地表面会增加电击风险。
- 3) 不得将电动工具暴露在雨中或潮湿环境中。水进入电动工具将增加电击风险。
- 4) 不得滥用软线。绝不能用软线搬运、拉动电动工具或拔出其插头。使软线远离热源、油、锐边或运动部件。受损或缠绕的软线会增加电击风险。
- 5) 当在户外使用电动工具时,使用适合户外使用的延长线。适合户外使用的电线将降低电击风险。
- 6) 如果无法避免在潮湿环境中操作电动工具,应使用带有剩余电流装置(RCD)保护的电源。RCD的使用可降低电击风险。

c) 人身安全

- 1) 保持警觉,当操作电动工具时关注所从事的操作并保持清醒。当你感到疲倦,或在有药物、酒精或治疗反应时,不要操作电动工具。在操作电动工具时瞬间的疏忽会导致严重人身伤害。
- 2) 使用个人防护装置。始终佩戴护目镜。防护装置,诸如适当条件下使用防尘面具、防滑安全鞋、安全帽、听力防护等装置能减少人身伤害。
- 3) 防止意外启动。在连接电源和/或电池包、拿起或搬运工具前确保开关处于关断位置。手指放在开关上搬运工具或开关处于接通时通电会导致危险。
- 4) 在电动工具接通之前,拿掉所有调节钥匙或扳手。遗留在电动工具旋转零件上的扳手或钥匙会导致人身伤害。
- 5) 手不要过分伸展。时刻注意立足点和身体平衡。这样能在意外情况下能更好地控制住电动工具。
- 6) 着装适当。不要穿宽松衣服或佩戴饰品。让你的头发和衣服远离运动部件。宽松衣服、配饰或长发可能会卷入运动部件。
- 7) 如果提供了与排屑、集尘设备连接用的装置,要确保其连接完好且使用得当。使用集尘装置可降低尘屑引起的危险。
- 8) 不要因为频繁使用工具而产生的熟悉感而掉以轻心,忽视工具的安全准则。某个粗心的动作可能在瞬间导致严重的伤害。

d) 电动工具使用和注意事项

- 1) 不要勉强使用电动工具,根据用途使用合适的电动工具。选用合适的按照额定值设计的电动工具会使你工作更有效、更安全。
- 2) 如果开关不能接通或关断电源,则不能使用该电动工具。不能通过开关来控制的电动工具是危险的且必须进行修理。
- 3) 在进行任何调节、更换附件或贮存电动工具之前,必须从电源上拔掉插头和/或卸下电池包(如可拆卸)。这种防护性的安全措施降低了电动工具意外启动的风险。
- 4) 将闲置不用电动工具贮存于儿童所及范围之外,并且不允许不熟悉电动工具和不了解这些说明的人操作电动工具。电动工具在未经培训的使用者手中是危险的。
- 5) 维护电动工具及其附件。检查运动部件是否调整到位或卡住,检查零件破损情况和影响电动工具运行的其他状况。如有损坏,应在使用前修理好电动工具。许多事故是由维护不良的电动工具引发的。
- 6) 保持切削刀具锋利和清洁。维护良好地有锋利切削刃的刀具不易卡住而且容易控制。
- 7) 按照使用说明,并考虑作业条件和要进行的作业来选择电动工具、附件和工具的刀头等。将电动工具用于那些与其用途不符的操作可能会导致危险情况。
- 8) 保持手柄和握持表面干燥、清洁,不得沾有油脂。在意外的情况下,湿滑的手柄不能保证握持的安全和对工具的控制。

e) 电池式工具使用和注意事项:

- 1) 仅使用生产者规定的充电器充电。将适用于某种电池包的充电器用到其他电池包时可能会发生着火危险。

- 2) 仅使用配有专用电池包的电动工具。使用其他电池包可能会产生伤害和着火危险。
- 3) 当电池包不用时, 将它远离其他金属物体, 例如回形针、硬币、钥匙、钉子、螺钉或其他小金属物体, 以防电池包一端与另一端连接。电池组端部短路会引起燃烧或着火。
- 4) 在滥用条件下, 液体可能会从电池组中溅出, 应避免接触。如果意外碰到液体, 用水冲洗。如果液体碰到了眼睛, 还应寻求医疗帮助。从电池中溅出的液体可能会发生腐蚀或燃烧。
- 5) 不要使用损坏或改装过的电池包或工具。损坏或改装过的电池组可能呈现无法预测的结果, 导致着火、爆炸或伤害。
- 6) 不要将电池包暴露于火或高温中。电池包暴露于火或高于130°C的高温中可能导致爆炸。

f) 维修

- 1) 让专业维修人员使用相同的备件维修电动工具。这将保证所维修的电动工具的安全。
- 2) 决不能维修损坏的电池包。电池包仅能由生产者或其授权的维修服务商进行维修。

冲击扳手安全警告 - 所有操作

- 当在紧固件可能触及暗线的场合进行操作时, 通过绝缘握持面握持工具。紧固件碰到带电导线会使工具外露金属零件带电而使操作者遭受电击。
 - 使用过程中要戴好耳罩。暴露在噪声中会引起听力损伤。
- 警告: 冲击扳手并非扭力扳手。请勿使用本工具将固定件拧至特定扭力。**应该使用经过校准的独立扭力测量设备(如扭力扳手)。固定件固定过紧或过松都会导致联结失效。



充电器

DeWALT 充电器无需做出任何调整, 专为简易操作而设计。

电气安全

电机只适用一种工作电压。请务必检查电池组的电压是否和铭牌上的电压一致。另外, 请确保充电器电压和主电源的电压一致。



DeWALT 充电器符合 IEC60335 双重绝缘要求, 因此无需使用接地线。

如果电源线损坏, 必须仅通过 DeWALT 或授权服务机构进行更换。

使用延长线

除非绝对必要, 否则请勿使用延长线。使用适合您的充电器输入功率的合格延长线(见技术参数)。最小的导线尺寸为 1 平方毫米; 最大长度为 30 米。

使用电缆卷筒时, 请务必拉出所有的电缆。

- 请佩戴安全护目镜或其他护目装备。冲击或钻孔会导致飞溅的碎片。飞溅的颗粒会对眼睛造成永久性伤害。
- 请勿长时间操作此工具。工具运行导致的振动可能会伤害您的手和手臂。使用手套提供额外缓冲, 经常停下休息, 限制使用时间。
- 附件和工具会在使用过程中发热。接触时请佩戴手套。

针对所有电池充电器的重要安全说明

请妥善保管好这些说明: 本手册包含重要的兼容电池充电器安全说明和操作说明(请参阅技术参数)。

- 在使用充电器之前, 请先阅读所有指示以及充电器、电池组和使用电池组的产品上的警示标记。



警告: 触电危险。请勿让任何液体渗入充电器, 否则会引起触电。



警告: 我们建议使用漏电保护额定电流为 30 毫安或以下的漏电保护装置。



警告: 灼伤危险。为降低人身伤害风险, 请仅使用 DeWALT 充电式电池充电。使用其它类型的电池可能会引起爆裂, 并导致人身伤害和损害。



警告: 应看管好儿童, 以确保他们不将此设备当做玩具来玩。

注意: 在某些情况下, 当充电器的插头插入电源插座时, 充电器内部裸露的充电接触点可能因为外来物件而短路。请勿让能导电的异物靠近充电器腔, 这些外来物件包括但不限于钢棉、铝箔或任何金属颗粒的堆积物。充电器内没有电池组时, 请断开充电器与电源的连接。清洗前, 务必拔掉充电器。

- 请勿试图使用本手册指定的充电器以外的其他任何充电器为电池组充电。充电器和电池组都是专门设计的, 互相配合使用。
- 除了为 DeWALT 充电式电池充电以外, 这些充电器并非设计用于其他用途。否则, 可能会导致火灾、触电或电击。
- 请勿将充电器暴露于雨中或雪中。
- 断开充电器连接时, 应按下插头, 切勿拉拽电源线。这将降低对电插头和电线的损害风险。
- 确保电源线布置在不易踩踏、踢绊、拉扯或会受到损害或压力的位置。
- 除非绝对必要, 否则请勿使用延长线。使用不正确的延长线可能导致火灾、触电或电击的风险。
- 请勿将任何物件放在充电器上面, 或是把充电器放在可能会堵住通风槽的柔软表面, 导致充电器的内部过热。请把充电器放置在远离任何热源的地方。充电器通过外壳顶端和底端的槽进行通风。
- 禁止使用电源线或插头已损坏的充电器。请立即更换这些充电器。
- 如果充电器受到强烈重击、掉落或出现其他损坏情况, 请勿使用充电器。请将损坏的充电器送到授权服务中心。
- 请勿自行拆卸充电器。需要维护或修理时, 请送到授权维修中心。重装不正确可能导致触电、电击或火灾风险。必须立即将已损坏的电源线交由制造商、服务代理或类似的合格人员进行更换以防止安全隐患。
- 清洁前, 请先断开充电器和插座的连接, 以降低触电风险。取出电池组不会降低此风险。
- 切勿将两个充电器连接在一起。
- 充电器是为 220-240 V 的标准家用电源而设计。请勿试图在任何其他电压下使用充电器。此规则不适用于车载充电器。

为电池充电 (图 B)

1. 放进电池组前, 先将充电器的插头插到相应的电源插座上。
2. 将电池组 ① 插入到充电器中, 确定电池组完全就位。红色(充电中)指示灯将不断闪烁, 表示充电过程已经开始。
3. 红色灯持续亮起表示充电完成。此时电池组已完全充电, 您可以使用电池组或将电池组留在充电器上。要从充电器上取下电池组, 请按电池组上的电池释放按钮 ②。

注: 为了确保锂离子电池的效能和使用寿命最大化, 在首次使用电池组之前必须将其完全充电。

充电器操作

关于电池组的充电状态，请参阅以下指示灯说明。

充电状态指示灯

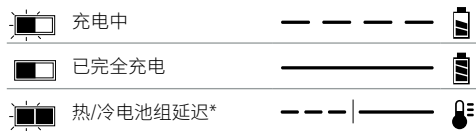

*红色指示灯会继续闪烁，但黄色指示灯在本次操作过程中会亮起。电池组达到适当温度后，黄色指示灯会熄灭，充电器将恢复充电程序。

此兼容充电器不能为故障的电池组充电。充电器指示灯不亮时表示电池有故障。

注:这也可能意味着充电器有故障。如果充电器提示存在故障，请将充电器和电池组送到授权的维修中心进行测试。

热/冷电池组延迟

当充电器检测到电池组过热或过冷时，它会启动热/冷电池延迟模式，暂停充电，直到电池组达到适当的温度。然后，充电器会自动切换到电池组充电模式。此功能可确保电池组拥有最长的使用寿命。

冷电池组充电速度比热电池组充电速度慢。电池组在整个充电周期的充电速度都会较慢，即使电池组升温也不会恢复到最大速度。

DCB118 充电器配备专用于冷却电池组的内部风扇。电池组需要冷却时，风扇会自动启动。如果风扇运转不正常或通风槽堵塞，切勿操作充电器。请勿让异物进入充电器内部。

电子保护系统

XR 锂离子电池工具具有电子保护系统设计，可保护电池组免受过载、过热或过度放电之害。

如果电子保护系统处于运作状态，该工具将自动停止操作。如果发生这种情况，请将锂离子电池组放在充电器上，直至其完全充电。

壁挂式安装

这些充电器设计为可以安装在墙上，也可以直立在桌面或工作台上。如果安装在墙上，请确保充电器的位置可以连接到电源插座，并且远离墙角或其他可能妨碍空气流通的障碍物。将充电器背面作为在墙上安装螺丝的位置模板。使用至少 25.4 毫米长、螺丝帽直径至少 7.9 毫米的石膏板螺丝（单独购买）牢固固定充电器，将螺丝最大限度打入木材，预留约 5.5 毫米露在墙外。将充电器背面的安装槽对准露出的螺丝，完全放置到位。

充电器清洁说明

警告: 触电危险。清洁前，请将充电器从交流电源插座上拔下。可用布或非金属软刷清除充电器外部的污垢和油脂。请勿使用水或任何清洁剂。切勿让任何液体渗入工具，切勿让工具的任何部件浸在液体中。

电池组

针对所有电池组的重要安全说明

在订购更换电池组时，请务必附上目录型号和电压。

包装箱内的电池组并未完全充电。使用电池组和充电器之前，请阅读下列安全指示，然后遵循所述的充电程序。

请阅读所有说明

- **请勿在易爆环境，如有易燃液体、气体或粉尘的环境中充电或使用电池。**在充电器中插入或取出电池时可能会点燃粉尘或气体。

- **切勿强行将电池放进充电器。请勿以任何方式改装电池组以在不相容的充电器中使用，否则电池组可能会破裂，导致严重人身伤害。**
- 只使用 DeWALT 充电器为电池组充电。
- **请勿** 喷溅电池组或将其浸泡在水或其他液体中。
- **请勿在温度可能低于 4°C (39.2°F) 的地方（如冬季户外的棚子或金属建筑物）或温度达到或超过 40°C (104°F) 的地方（如夏季户外的棚子或金属建筑物）存储或使用工具和电池组。**
- **即使电池组严重受损或完全损坏，也请勿焚化电池组。** 电池组在火中会发生爆炸。锂离子电池在燃烧时会释放有毒烟雾和物质。
- **如果电池液体接触到皮肤，请立即以中性肥皂和清水冲洗接触的地方。** 如果电池液体不慎进入眼睛，应睁开眼睛并用清水冲洗至少 15 分钟或直到刺激感消失。如果需要医疗救助，请告知医护人员。电池电解质由液状有机碳酸盐和锂盐的混合物组成。
- **已打开电池的內部物质可能导致呼吸道刺激。** 请保持空气流通。如果症状持续存在，请就医。



警告: 灼伤危险。 电池液如果接触到火花或火焰可能会燃烧。



警告: 切勿以任何理由试图打开电池组。电池组外壳破裂或损坏时，请勿将电池组插入充电器。请勿挤压、掉落或损坏电池组。请勿使用受过强烈冲击、掉落、碾压或以任何其它方式（如被钉子穿破、受到锤子的重击、踩踏）受损的电池组或充电器。否则可能会引起触电或电击。损坏的电池组应送回维修中心进行回收。



警告: 火灾危险。请勿在存储或搬运电池组时让金属物品接触暴露的电池两极。 例如，请勿将电池组放在围裙、口袋、工具箱、产品套件盒、抽屉等可能与散钉、螺丝、钥匙等物品接触的地方。



警告: 不用时，将工具侧放在平稳的表面上，确保不会有绊绳或掉落的危险。 一些具有大型电池组的工具可以直立但可能会轻易被撞倒。

运输



警告: 火灾危险。 电池运输途中，如果电池两极意外接触导电材料，可能会引发火灾。运输电池时，务必保护电池两极，确保与可能接触电池导致短路的材料良好绝缘。**注:** 锂离子电池不应放在托运行李中。

DeWALT 电池符合所有适用的行业和法律标准规定的运输规范，包括《联合国危险品运输建议规章范本》(UN Recommendations on the Transport of Dangerous Goods)、《国际航空运输协会 (IATA) 危险品规则》(International Air Transport Association (IATA) Dangerous Goods Regulations)、《国际海运危险品 (IMDG) 规则》(International Maritime Dangerous Goods (IMDG) Regulations) 和《欧洲危险货物国际公路运输协定》(European Agreement Concerning The International Carriage of Dangerous Goods by Road) (ADR)。锂离子电池和电池组已遵循《联合国危险品运输建议规章范本手册》第 38.3 节关于测试和标准的说明通过测试。

大多数情况下，发运 DeWALT 电池组不属于完全管制的 9 类危险品。通常情况下，只有当运输包含一个能量等级大于 100 瓦时 (Wh) 的锂离子电池时，才需要作为完全管制的 9 类危险品发运。所有锂离子电池外壳上均标有瓦时等级。此外，由于法规比较复杂，无论瓦时等级是多少，DeWALT 都不建议单独空运锂离子电池。发运包含电池的工具体（组合套件）时，如果电池组的额定能量不大于 100 瓦时 (Wh)，则可以空运。

无论发运是否纳入完全管制范围内，运输公司均有责任遵循最新法规中关于包装、标签/标记和单据的要求。

本手册本节的信息是出于善意提供，且认为在编制文档时准确无误。但是不提供明示或暗示的担保。购买方负有确保其行为遵守适用法规的责任。

运输 FLEXVOLT™ 电池

DeWALT FLEXVOLT™ 电池有两种模式：**使用**和**运输**。

使用模式：当 FLEXVOLT™ 电池单独使用或用于 DeWALT 18 伏(最大 20 伏)产品时，将作为功率为 18 伏(最大 20 伏)的电池进行操作。当 FLEXVOLT™ 电池用于 54 伏(最大 60 伏)或 108 伏(最大 120 伏)(两个 54 伏(最大 60 伏)电池)的产品时，将作为 54 伏(最大 60 伏)的电池进行操作。

运输模式：当电池盖连接到 FLEXVOLT™ 电池时，电池会进入运输模式。保留电池盖用于运输。

处于运输模式时，电池组内部的电池芯会处于断电状态，使 3 个低瓦时 (Wh) 等级的电池相当于 1 个高瓦时等级电池。这样，增加 3 个低瓦时等级的电池可以使电池组不必遵守适用于更高瓦时电池的运输法规。

例如，若运输额定瓦时为 3 x 36 瓦时，则表示 3 个 36 瓦时的电池。使用瓦时额定值可能是 108 瓦时(表示 1 个电池)。

使用和运输标签标记示例



存放建议

1. 最好将电池存放在阴凉、干燥、远离阳光直射、不会过热或过冷的地方。为了获得最佳的电池性能和使用寿命，请您在不使用电池组时将其存储在室温下。
2. 长期存储时，建议将完全充电的电池组从充电器取出，存储在阴凉、干燥的地方，以达到最佳效果。

注：电池组不应在电池已完全耗尽的状态下存放。使用电池组之前，必须重新为电池组充电。

充电器和电池组上的标签

除了在本手册中所使用的标志，充电器和电池组的标签还包括：



使用前请阅读使用手册。



要了解充电时间，请参阅**技术参数**。



请勿使用导电物体戳刺。



请勿对损坏的电池组充电。



请勿将其暴露于水中。



应立即更换有缺陷的电线。



请只在 4°C 和 40°C 之间的温度下充电。



只能在室内使用。



弃置电池组时，请妥善处理以保护我们的环境。



只使用指定的 DeWALT 充电器为 DeWALT 电池组充电。使用 DeWALT 充电器为非 DeWALT 电池充电可能会导致电池爆炸或出现其他危险情况。



请勿焚化电池组。



使用(无电池盖)。示例：瓦时额定值为 108 瓦时(1 个 108 瓦时的电池)。



运输(有内置运输盖)。示例：瓦时额定值为 3 x 36 瓦时(3 个 36 瓦时的电池)。

电池类型

以下工具在 18 (最大 20 伏) 伏电池组上运行：DCF911。这些电池组可用于：DCB181、DCB182、DCB183、DCB184、DCB185、DCB187、DCB189、DCB203、DCB204、DCB205、DCB546、DCB547、DCB548、DCB606、DCB609、DCB612 和 DCBP034。更多信息，请参阅**技术参数**。

包装内的物品

包装内的物品包括：

- 1 个 冲击扳手
- 1 个 充电器 (DCF911N 内不包含)
- 1 个 皮带扣
- 1 个 锂离子电池组 (C1、D1、E1、L1、M1、P1、S1、T1、X1、Y1 型号)
- 2 个 锂离子电池组 (C2、D2、E2、L2、M2、P2、S2、T2、X2、Y2 型号)
- 3 个 锂离子电池组 (C3、D3、E3、L3、M3、P3、S3、T3、X3、Y3 型号)
- 1 本 说明手册

工具上的标记

工具上印有列图形：



使用前请阅读使用手册。



请佩戴听力保护器。



请佩戴护目装备。



可见辐射。切勿直视激光束。

日期码位置(图 B)

日期码 **10** 印在工具外壳上，其中还包含制造年份。

示例：

2021 XX XX
制造年份和星期

说明(图 A、B)

警告:切勿改装本电动工具或其任何部件,否则可能会导致损坏或人身伤害。

- 1 电池组
- 2 电池释放按钮
- 3 无级变速开关
- 4 正/反转控制按钮
- 5 铁砧
- 6 主握柄
- 7 工作灯
- 8 皮带扣
- 9 螺丝

设计用途

这些冲击扳手专为专业冲击锁紧应用而设计。冲击功能使这个工具非常有用,特别是在木材、金属和混凝土中钻紧固件这方面。

请勿在潮湿环境中或在易燃液体或气体存在的环境中使用本工具。

这些冲击扳手是专业电动工具。

请勿让儿童接触工具。缺乏经验的操作员需要在监督下使用本工具。

- **儿童和体弱者。**在没有他人监督的情况下,儿童或体弱者不适宜使用本产品。
- 本产品不适合体力、感官或智力不足以及缺乏经验、知识或技能的人员(包括儿童)使用,除非一旁有能为他们的安全负责的监督人员。不得在无人监管的情况下让儿童接触本产品。

组装与调整

警告:为降低严重的人身伤害风险,在进行任何调整或取出/安装附件或配件之前,请关闭工具并断开电池组连接。意外启动可能会导致人身伤害。

警告:只使用 DEWALT 电池组和充电器。

插入或取出工具上的电池组(图 B)

注:请确保您的电池组 1 已完全充电。

将电池组安装到工具手柄中

1. 将电池组 1 对齐工具手柄内的轨道(图 B)。
2. 将电池组滑入手柄内,使其牢牢地固定在工具内,并确保您听到其锁定到位的声音。

从工具中取出电池组

1. 按下释放按钮 2,将电池组从工具握柄中稳妥地拉出。
2. 按本手册充电器部分所述将电池组插入充电器中。

电池组电量计(图 B)

一些 DEWALT 电池组内包括一个由三个绿色 LED 指示灯组成的电量计,以用于指示电池组中剩余的电量。

如需启动电量计,请按住电量计按钮 11。三个绿色 LED 指示灯将以组合方式亮起,以指示剩余电量。当电池内的电量低于可用限时,电量计将不会亮起,电池将需要重新充电。

注:电量计仅指示电池组的剩余电量。它并不表示该工具的功能,且将根据产品组件、温度和最终用户的使用情况而有所不同。

皮带扣(图 A)

警告:为降低严重的人身伤害风险,在进行任何调整或取出/安装附件或配件之前,请关闭工具并断开电池组连接。

警告:为降低严重的人身伤害风险,请不要将工具悬挂在头顶上方或用皮带扣悬挂物品。只能使用工作皮带悬挂工具的皮带扣。

警告:为了降低严重人身伤害的危险,请确保固定皮带扣子的螺丝是牢固的。

警告:为了降低人身伤害或损坏风险,请勿使用皮带扣将电钻挂起来当作聚光灯。

重要:安装或更换皮带扣时,请仅使用提供的螺丝 9。务必拧紧螺丝。

可使用提供的螺丝 9 将皮带扣 8 装到工具的任意一侧,以方便习惯左手操作或习惯右手操作的用户使用。无需皮带扣时,可以从工具上拆除。

若要拆除皮带扣,请取下固定它们的螺丝 9,然后在另一边重新装上。务必拧紧螺丝。

无级变速开关及正/反转控制按钮(图 C)

电钻通过按下和松开无级变速开关 3 开启和关闭。无级变速开关按得越深,工具速度就越快。您的工具配备制动器。无级变速开关完全松开时夹头将停止运作。

正/反转控制按钮 4 可确定工具旋转方向,并可作为锁定按钮使用。

- 若要选择正向旋转(顺时针),请松开无级变速开关,然后按下工具右侧的正/反转控制按钮。
- 如果要选择反向旋转(逆时针),请按下工具左侧的正/反转控制按钮。

注:控制按钮的中心位置会将工具锁定在关闭位置。改变控制按钮的位置时,确保无级变速开关处于松开状态。

注:不建议在变速范围内连续使用工具,否则可能会损坏开关,因此应尽量避免。

注:改变旋转方向后第一次运行工具时,您可能会在启动时听到“咔嚓声”。这是正常现象,并不表示出现问题。

工作灯(图 A)

按压触发开关时,工作灯 7 就会亮起,并将在松开触发开关后的 20 秒自动关闭。如果无级变速开关处于按下状态,则工作灯将持续亮起。

注:工作灯用于照亮紧邻的工作表面,不能当做手电筒使用。

铁砧(图 A、D)

警告:仅能使用冲击型附件。非冲击型配件可能会破裂和导致危险情况。使用配件之前,请检查配件是否处于良好状态且无裂痕。

警告:使用前,请检查铁砧、定位销和猪扣环。使用前应该更换丢失或损坏的物件。

更换附件之前,将开关置于锁止(中心)位置或拆除电池组。要将附件安装在猪环扣铁砧上,请稳固地将附件推到铁砧 5 上。猪环扣将压缩,以便使附件在其上滑动。安装附件之后,猪环扣会施加压力以帮助固定附件。

要拆除附件,请抓紧附件并稳固地将其取下。

操作

使用说明



警告: 务必遵守安全指示和适用法规。



警告: 为降低严重的人身伤害风险, 在进行任何调整或取出/安装附件或配件之前, 请关闭工具并断开电池组连接。意外启动可能会导致人身伤害。

正确的手持方式(图 E)



警告: 为降低严重的人身伤害风险, 请务必使用正确的手持方式, 如图所示。



警告: 为降低严重人身伤害的风险, 请务必紧握工具以防止意外事件。

正确的手持位置是一只手握住主握柄 6。

用法(图 A)



警告: 确保紧固件和/或系统能够承受由工具生成的扭矩水平。过大的扭矩可能会造成破损和人身伤害。

1. 将附件放到紧固件头上。保持工具指向紧固件。
2. 按下无级变速开关 3 以开始运转。松开无级变速开关以停止运转。由于紧固扭矩受以下因素影响, 请务必使用扭矩扳手检查扭矩:
 - **电压:** 因几乎完全放电而产生的低电压会降低紧固扭矩。
 - **配件尺寸:** 使用尺寸不正确的配件会使紧固扭矩变小。
 - **螺栓尺寸:** 螺栓直径越大, 通常需要的紧固力矩越大。紧固扭矩也将会视长度、等级和扭矩系数有所不同。
 - **螺栓:** 确保所有螺纹未生锈且没有其他碎屑, 以便产生适当的紧固扭矩。
 - **材料:** 材料的类型和材料的表面涂层都会影响紧固扭矩。
 - **紧固时间:** 紧固时间越长, 紧固扭矩越大。如果紧固时间比建议的紧固时间长, 可能会导致紧固件不堪重负、剥离或损坏。

维护

您的电动工具设计精良, 可以长期使用, 仅需极少维护。要持续获得令人满意的工作效果, 需要进行合适的工具维护和定期清洁。



警告: 为降低严重的人身伤害风险, 在进行任何调整或取出/安装附件或配件之前, 请关闭工具并断开电池组连接。意外启动可能会导致人身伤害。

充电器和电池组无法维修。



润滑

本电动工具无需另行润滑。



清洁



警告: 一旦看到通风口及其周围积聚了尘屑, 请用干燥的空气将灰尘和尘屑从主机外壳内吹出。执行此过程时, 需戴上经认可的护目装备和防尘面具。



警告: 请勿使用溶剂或其它刺激性化学制品来清洁工具的非金属部件。这些化学物质可能会削弱这些部位使用的材料。请用布蘸温和的肥皂水擦拭。切勿让任何液体渗入工具, 切勿让工具的任何部件浸在液体中。

可选配件



警告: 除了 DeWALT 提供的附件之外, 其他附件都未经此产品兼容性测试, 若将此类附件与本工具一起使用将存在安全隐患。为降低人身伤害风险, 本产品只可使用 DeWALT 推荐的附件。

请向您的经销商咨询更多关于合适附件的信息。

保护环境



分类回收。由此符号标记的产品和电池不得与普通家庭垃圾一起处理。

产品和电池包含可恢复或回收的材料, 从而降低对原材料的需求。请根据当地供给回收电子产品和电池。要获得更多信息, 请参看 www.2helpU.com。

充电式电池组

本电池组使用寿命长, 不能提供顺利完成工作所需的电力时, 必须进行充电。电池技术寿命结束时, 请妥善处理以保护环境:

- 耗尽电池组的电力, 然后从工具上拆下。
- 锂离子电池是可回收的。请将它们送往您的经销商处或当地的回收站。回收的电池组将被妥善循环使用或处理。

售后服务与维修

- DEWALT 服务中心拥有训练有素的人员, 为客户提供高效和可靠的产品服务。
- 如果您在未经授权的服务中心进行维修, 我们将不承担任何责任。您可以参考产品包装中的联系中心定位器 (CONTACT CENTER LOCATOR) 宣传单, 通过热线、网站或社交媒体与我们联系, 以找到离您最近的 DEWALT 服务中心。

制造商: 百得美国公司

地址: 701 E Joppa Rd, TW050 MD21286, Towson, 美国

产地: 江苏苏州

产品中有害物质的名称及含量

部件名称	有害物质					
	铅 (Pb)	汞 (Hg)	镉 (Cd)	六价铬 (Cr(VI))	多溴联苯 (PBB)	多溴二 苯醚 (PBDE)
马达组件	O	O	O	O	O	O
机壳组件	O	O	O	O	O	O
控制部件 (开关, PCB 等)	X	O	O	O	O	O
传动部件	O	O	O	O	O	O
电池包	X	O	O	O	O	O
充电器	X	O	O	O	O	O
附件 (钻头/砂轮片等)	O	O	O	O	O	O
电线组件	X	O	O	O	O	O

本表格依据SJ/T 11364的规定编制。

O: 标识该有害物质在该部位所有均质材料中的含量均在GB/T 26572规定的限量要求以下。

X: 标识该有害物质至少在该部位的某一均质材料中的含量超出GB/T 26572规定的限量要求。

备注: 本产品不必包含以上所述的所有部件。由于生产工艺和技术的不可替代性, 本产品中含有某些有害物质, 在环保使用期限内可以放心使用, 超过环保使用期限之后则应进入回收循环系统。

环保使用期限为“电子电气产品中含有的有害物质不会发生外泄或突变, 电子电气产品用户正常使用该电子电气产品不会对环境造成严重污染或对其人身、财产造成严重损害的期限”。



: 环保使用期限为20年。此环保使用期限不代表产品的安全使用期限和质量保证年限。

