

DEWALT®

XR LI-ION

English (*original instructions*)

4

简体中文

19

Fig. A
图 A

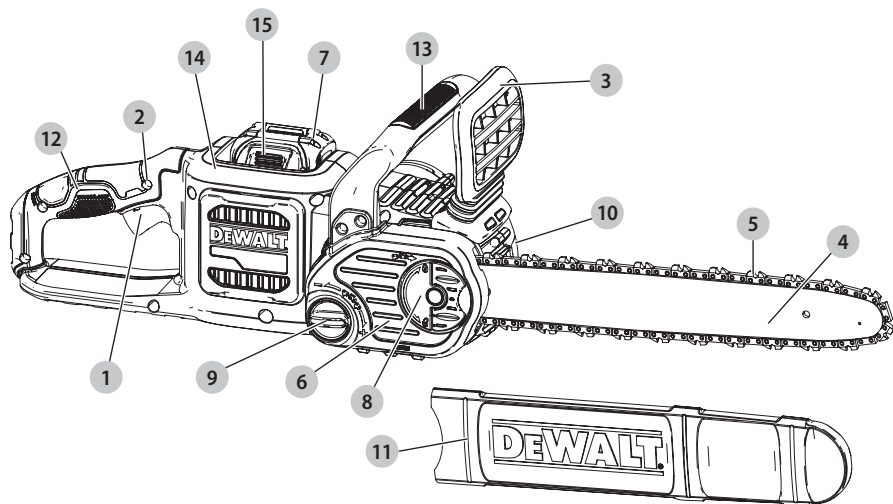


图 B
Fig. B

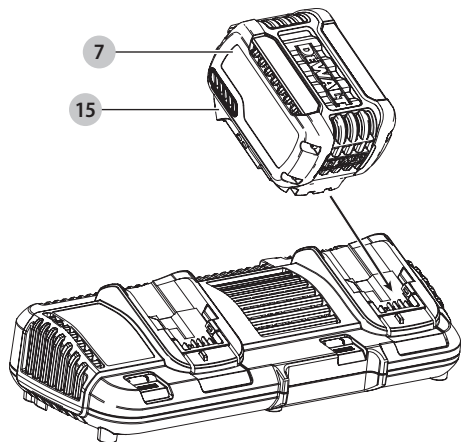


Fig. C
图 C

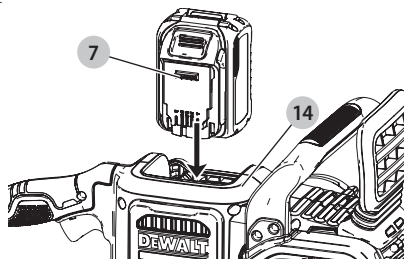


Fig. D
图 D

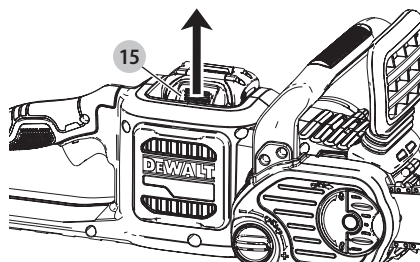


Fig. E
图 E

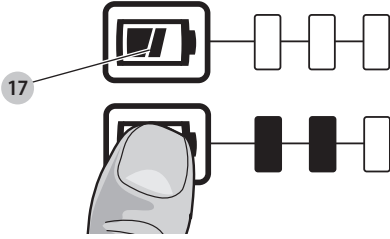


Fig. F
图 F

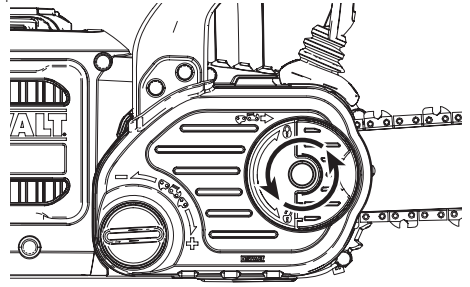


Fig. G
图 G

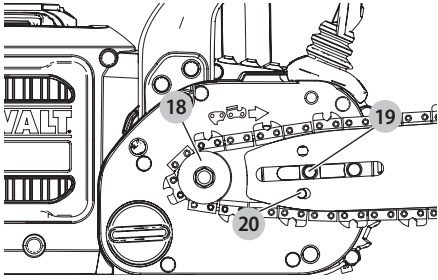


Fig. H
图 H

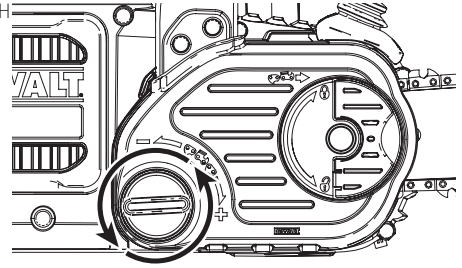


Fig. I
图 I

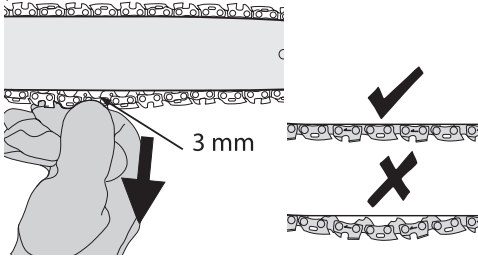


Fig. J
图 J

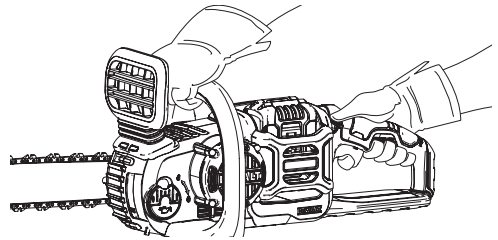


Fig. K
图 K

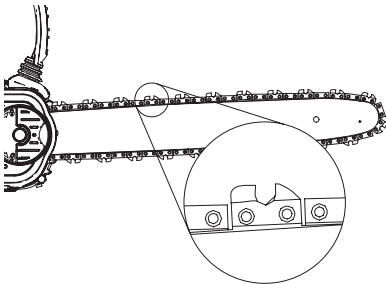


Fig. L
图 L

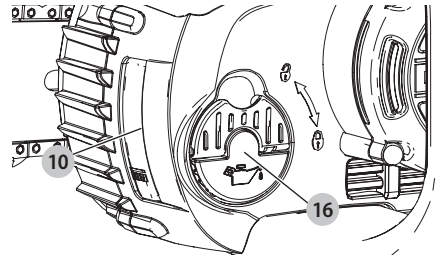


Fig. M
图 M

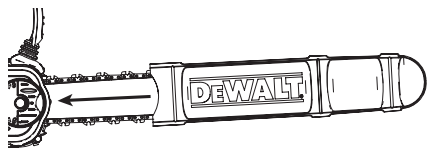


Fig. N
图 N

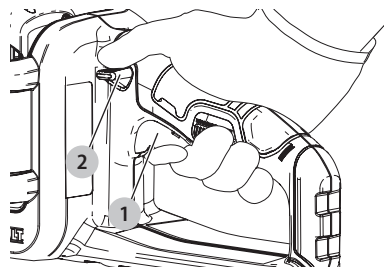


Fig. O
图 O

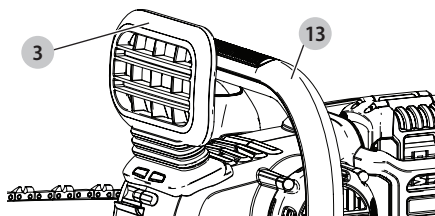


Fig. P
图 P

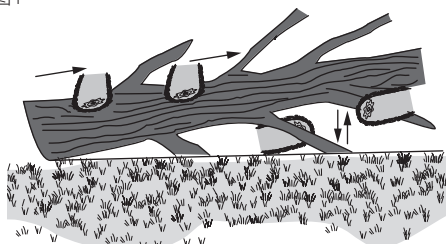


Fig. Q
图 Q

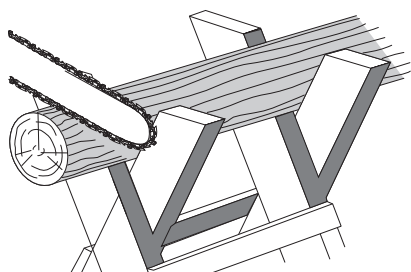


Fig. R
图 R

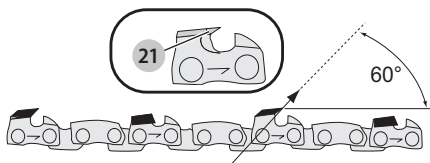


Fig. S
图 S

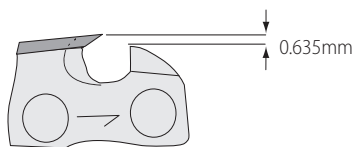
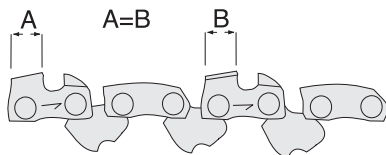


Fig. T
图 T



60V MAX CHAINSAW

DCM575

Congratulations!

You have chosen a DEWALT tool. Years of experience, thorough product development and innovation make DEWALT one of the most reliable partners for professional power tool users.

Technical Data

			DCM575
Voltage	V _{DC}		54(60 Max)
Battery type			Li-Ion
Bar Length	cm		40
Maximum Chain Speed (no-load)	m/s		15
Maximum Cutting Length	cm		40
Oil Capacity	ml		115
Weight (without battery pack)	kg		4.4

Batteries				Chargers / Charge Times (Minutes)							
Cat#	V _{DC}	Ah	Weight(kg)	DCB104	DCB107	DCB112	DCB115	DCB117	DCB118	DCB132	DCB1112
DCB546/DCB606	18/54 (20/60 Max)	6.0/2.0	1.05	60	270	170	90	40	60	90	40
DCB547/DCB609	18/54 (20/60 Max)	9.0/3.0	1.46	75*	420	270	135*	60	75*	135*	60
DCB548/DCB612	18/54 (20/60 Max)	12.0/4.0	1.44	120	540	350	180	80	120	180	80
DCB181	18 (20 Max)	1.5	0.35	22	70	45	22	22	22	22	22
DCB182/DCB204	18 (20 Max)	4.0	0.61	60/40**	185	120	60	60/40**	60/40**	60	60/40**
DCB183/DCB203	18 (20 Max)	2.0	0.40	30	90	60	30	30	30	30	30
DCB184/DCB205	18 (20 Max)	5.0	0.62	75/50**	240	150	75	75/50**	75/50**	75	75/50**
DCB185	18 (20 Max)	1.3	0.35	22	60	40	22	22	22	22	22
DCB187	18 (20 Max)	3.0	0.54	45	140	90	45	45	45	45	45
DCB189/DCB240	18 (20 Max)	4.0	0.54	60	185	120	60	60	60	60	60
DCB186	18 (20 Max)	6.0	0.95	60	270	170	90	60	60	90	60

*Date code 201811475B or later

**Date code 201536 or later



WARNING: To reduce the risk of injury, read the instruction manual.

Definitions: Safety Guidelines

The definitions below describe the level of severity for each signal word. Please read the manual and pay attention to these symbols.



DANGER: Indicates an imminently hazardous situation which, if not avoided, **will** result in **death or serious injury**.



WARNING: Indicates a potentially hazardous situation which, if not avoided, **could** result in **death or serious injury**.



CAUTION: Indicates a potentially hazardous situation which, if not avoided, **may** result in **minor or moderate injury**.



NOTICE: Indicates a practice **not related to personal injury** which, if not avoided, **may** result in **property damage**.



Denotes risk of electric shock.



Denotes risk of fire.

General Power Tool Safety Warnings



WARNING: Read all safety warnings and all instructions. Failure to follow the warnings and instructions may result in electric shock, fire and/or serious injury.

SAVE ALL WARNINGS AND INSTRUCTIONS FOR FUTURE REFERENCE

The term "power tool" in the warnings refers to your mains-operated (corded) power tool or battery-operated (cordless) power tool.

1) Work area safety

- a) **Keep work area clean and well lit.** Cluttered or dark areas invite accidents.
- b) **Do not operate power tools in explosive atmospheres, such as in the presence of flammable liquids, gases or dust.** Power tools create sparks which may ignite the dust or fumes.
- c) **Keep children and bystanders away while operating a power tool.** Distractions can cause you to lose control.

2) Electrical safety

- a) **Power tool plugs must match the outlet. Never modify the plug in any way. Do not use any adapter plugs with earthed (grounded) power tools.**
Unmodified plugs and matching outlets will reduce risk of electric shock.
- b) **Avoid body contact with earthed or grounded surfaces such as pipes, radiators, ranges and refrigerators.** There is an increased risk of electric shock if your body is earthed or grounded.
- c) **Do not expose power tools to rain or wet conditions.** Water entering a power tool will increase the risk of electric shock.
- d) **Do not abuse the cord. Never use the cord for carrying, pulling or unplugging the power tool. Keep cord away from heat, oil, sharp edges or moving parts.** Damaged or entangled cords increase the risk of electric shock.
- e) **When operating a power tool outdoors, use an extension cord suitable for outdoor use.** Use of a cord suitable for outdoor use reduces the risk of electric shock.
- f) **If operating a power tool in a damp location is unavoidable, use a residual current device (RCD) protected supply.** Use of an RCD reduces the risk of electric shock.

3) Personal safety

- a) **Stay alert, watch what you are doing and use common sense when operating a power tool. Do not use a power tool while you are tired or under the influence of drugs, alcohol or medication.** A moment of inattention while operating power tools may result in serious personal injury.

- b) **Use personal protective equipment. Always wear eye protection.** Protective equipment such as dust mask, non-skid safety shoes, hard hat, or hearing protection used for appropriate conditions will reduce personal injuries.
- c) **Prevent unintentional starting. Ensure the switch is in the off position before connecting to power source and/or battery pack, picking up or carrying the tool.** Carrying power tools with your finger on the switch or energising power tools that have the switch on invites accidents.
- d) **Remove any adjusting key or wrench before turning the power tool on.** A wrench or a key left attached to a rotating part of the power tool may result in personal injury.
- e) **Do not overreach. Keep proper footing and balance at all times.** This enables better control of the power tool in unexpected situations.
- f) **Dress properly. Do not wear loose clothing or jewellery. Keep your hair, clothing and gloves away from moving parts.** Loose clothes, jewellery or long hair can be caught in moving parts.
- g) **If devices are provided for the connection of dust extraction and collection facilities, ensure these are connected and properly used.** Use of dust collection can reduce dust-related hazards.
- h) **Do not let familiarity gained from frequent use of tools allow you to become complacent and ignore tool safety principles.** A careless action can cause severe injury within a fraction of a second.

4) Power tool use and care

- a) **Do not force the power tool. Use the correct power tool for your application.** The correct power tool will do the job better and safer at the rate for which it was designed.
- b) **Do not use the power tool if the switch does not turn it on and off.** Any power tool that cannot be controlled with the switch is dangerous and must be repaired.
- c) **Disconnect the plug from the power source and/or the battery pack from the power tool before making any adjustments, changing accessories, or storing power tools.** Such preventive safety measures reduce the risk of starting the power tool accidentally.
- d) **Store idle power tools out of the reach of children and do not allow persons unfamiliar with the power tool or these instructions to operate the power tool.** Power tools are dangerous in the hands of untrained users.
- e) **Maintain power tools. Check for misalignment or binding of moving parts, breakage of parts and any other condition that may affect the power tool's operation. If damaged, have the power tool repaired before use.** Many accidents are caused by poorly maintained power tools.
- f) **Keep cutting tools sharp and clean.** Properly maintained cutting tools with sharp cutting edges are less likely to bind and are easier to control.

- g) **Use the power tool, accessories and tool bits etc., in accordance with these instructions taking into account the working conditions and the work to be performed.** Use of the power tool for operations different from those intended could result in a hazardous situation.
- h) **Keep handles and grasping surfaces dry, clean and free from oil and grease.** Slippery handles and grasping surfaces do not allow for safe handling and control of the tool in unexpected situations.

5) Battery tool use and care

- a) **Recharge only with the charger specified by the manufacturer.** A charger that is suitable for one type of battery pack may create a risk of fire when used with another battery pack.
- b) **Use power tools only with specifically designated battery packs.** Use of any other battery packs may create a risk of injury and fire.
- c) **When battery pack is not in use, keep it away from other metal objects like paper clips, coins, keys, nails, screws or other small metal objects that can make a connection from one terminal to another.** Shorting the battery terminals together may cause burns or a fire.
- d) **Under abusive conditions, liquid may be ejected from the battery; avoid contact. If contact accidentally occurs, flush with water. If liquid contacts eyes, additionally seek medical help.** Liquid ejected from the battery may cause irritation or burns.
- e) **Do not use a battery pack or tool that is damaged or modified.** Damaged or modified batteries may exhibit unpredictable behaviour resulting in fire, explosion or risk of injury.
- f) **Do not expose a battery pack or tool to fire or excessive temperature.** Exposure to fire or temperature above 130 °C may cause explosion.
- g) **Follow all charging instructions and do not charge the battery pack or tool outside the temperature range specified in the instructions.** Charging improperly or at temperatures outside the specified range may damage the battery and increase the risk of fire.

6) Service

- a) **Have your power tool serviced by a qualified repair person using only identical replacement parts.** This will ensure that the safety of the power tool is maintained.
- b) **Never service damaged battery packs.** Service of battery packs should only be performed by the manufacturer or authorized service providers.

Additional Chainsaw Safety Warnings



WARNING: Additional safety warnings for chainsaws.

- **Keep all parts of the body away from the saw chain when the chain saw is operating. Before you start the chain saw, make sure the saw chain is not contacting anything.** A moment of inattention while operating chain

saws may cause entanglement of your clothing or body with the saw chain.

- **Always hold the chain saw with your right hand on the rear handle and your left hand on the front handle.** Holding the chain saw with a reversed hand configuration increases the risk of personal injury and should never be done.
- **Hold the chain saw by insulated gripping surfaces only, because the saw chain may contact hidden wiring.** Saw chains contacting a "live" wire may make exposed metal parts of the chain saw "live" and could give the operator an electric shock.
- **Wear eye protection. Further protective equipment for hearing, head, hands, legs and feet is recommended.** Adequate protective equipment will reduce personal injury from flying debris or accidental contact with the saw chain.
- **Do not operate a chain saw in a tree, on a ladder, from a rooftop, or any unstable support.** Operation of a chain saw in this manner could result in serious personal injury.
- **Always keep proper footing and operate the chain saw only when standing on fixed, secure and level surface.** Slippery or unstable surfaces such as ladders may cause a loss of balance or control of the chain saw.
- **When cutting a limb that is under tension be alert for spring back.** When the tension in the wood fibers is released the spring loaded limb may strike the operator and/or throw the chain saw out of control.
- **Use extreme caution when cutting brush and saplings.** The slender material may catch the saw chain and be whipped toward you or pull you off balance.
- **Carry the chain saw by the front handle with the chain saw switched off and away from your body. When transporting or storing the chain saw always fit the guide bar cover.** Proper handling of the chain saw will reduce the likelihood of accidental contact with the moving saw chain.
- **Follow instructions for lubricating, chain tensioning and changing accessories.** Improperly tensioned or lubricated chain may either break or increase the chance for kickback.
- **Keep handles dry, clean, and free from oil and grease.** Greasy, oily handles are slippery causing loss of control.
- **Cut wood only. Do not use chain saw for purposes not intended. For example: do not use chain saw for cutting plastic, masonry or non-wood building materials.** Use of the chain saw for operations different than intended could result in a hazardous situation.
- **Do not attempt to fell a tree until you have an understanding of the risks and how to avoid them.** Serious injury could occur to the operator or bystanders while felling a tree.
- **This chain saw is not intended for tree felling.** Use of the chain saw for operations different than intended could result in serious injury to the operator or bystanders.

Causes and Operator Prevention of Kickback:

Kickback may occur when the nose or tip of the guide bar touches an object, or when the wood closes in and pinches the saw chain in the cut.

Tip contact in some cases may cause a sudden reverse reaction, kicking the guide bar up and back towards the operator.

Pinching the saw chain along the top of the guide bar may push the guide bar rapidly back towards the operator.

Either of these reactions may cause you to lose control of the saw which could result in serious personal injury. Do not rely exclusively upon the safety devices built into your saw. As a chain saw user, you should take several steps to keep your cutting jobs free from accident or injury.

Kickback is the result of tool misuse and/or incorrect operating procedures or conditions and can be avoided by taking proper precautions as given below:

- **Maintain a firm grip, with thumbs and fingers encircling the chain saw handles, with both hands on the saw and position your body and arm to allow you to resist kickback forces.** Kickback forces can be controlled by the operator, if proper precautions are taken. Do not let go of the chain saw.
- **Do not overreach and do not cut above shoulder height.** This helps prevent unintended tip contact and enables better control of the chain saw in unexpected situations.
- **Only use replacement bars and chains specified by the manufacturer.** Incorrect replacement bars and chains may cause chain breakage and/or kickback.
- **Follow the manufacturer's sharpening and maintenance instructions for the saw chain.** Decreasing the depth gauge height can lead to increased kickback.

General chain saw safety warnings

- a) **Follow all instructions when clearing jammed material, storing or servicing the chain saw. Make sure the switch is off and the battery pack is removed.** Unexpected actuation of the chain saw while clearing jammed material or servicing may result in serious personal injury.

The Following Precautions Should Be Followed to Minimize Kickback:

1. **Grip saw firmly. Hold the chain saw firmly with both hands when the motor is running. Use a firm grip with thumbs and fingers encircling the chain saw handles.** Chain saw will pull forward when cutting on the bottom edge of the bar, and push backward when cutting along the top edge of the bar.
2. **Do not over reach.**
3. **Keep proper footing and balance at all times.**
4. **Don't let the nose of the guide bar contact a log, branch, ground or other obstruction.**
5. **Don't cut above shoulder height.**
6. **Use devices such as low kickback chain and reduced kickback guide bars that reduce the risks associated with kickback.**
7. **Only use replacement bars and chains specified by the manufacturer or the equivalent.**
8. **Never let the moving chain contact any object at the tip of the guide bar.**
9. **Keep the working area free from obstructions such as other trees, branches, rocks, fences, stumps, etc.** Eliminate or avoid any obstruction that your saw chain could hit while you are cutting through a particular log or branch.
10. **Keep your saw chain sharp and properly tensioned. A loose or dull chain can increase the chance of kickback.** Check tension at regular intervals with the motor stopped and tool unplugged, never with the motor running.
11. **Begin and continue cutting only with the chain moving at full speed.** If the chain is moving at a slower speed, there is a greater chance for kickback to occur.
12. **Cut one log at a time.**
13. **Use extreme caution when re-entering a previous cut.** Engage ribbed bumpers into wood and allow chain to reach full speed before proceeding with cut.
14. **Do not attempt plunge cuts or bore cuts.**
15. **Watch for shifting logs or other forces that could close a cut and pinch or fall into chain.**

Kickback Safety Features



WARNING: The following features are included on your saw to help reduce the hazard of kickback; however such features will not totally eliminate this dangerous reaction. As a chain saw user do not rely only on safety devices. You must follow all safety precautions, instructions, and maintenance in this manual to help avoid kickback and other forces which can result in serious injury.

- **Reduced-Kickback Guide Bar**, designed with a small radius tip which reduces the size of the kickback danger zone on bar tip. A reduced - kickback guide bar is one which has been demonstrated to significantly reduce the number and seriousness of kickbacks when tested in accordance with safety requirements for electric chain saws.
- **Low-Kickback Chain**, designed with a contoured depth gauge and guard link which deflect kickback force and allow wood to gradually ride into the cutter.
- Do not operate chain saw while in a tree, on a ladder, on a scaffold, or from any unstable surface.
- Hold tool by insulated gripping surfaces when performing an operation where the cutting tool may contact hidden wiring. Contact with a "live" wire will make exposed metal parts of the tool "live" and shock the operator.
- Do not attempt operations beyond your capacity or experience. Read thoroughly and understand completely all instructions in this manual.
- Before you start chain saw, make sure saw chain is not contacting any object.

- Do not operate a chain saw with one hand! Serious injury to the operator, helpers, or bystanders may result from one handed operation. A chain saw is intended for two-handed use only.
- Keep the handles dry, clean, and free of oil or grease.
- Do not allow dirt, debris, or sawdust to build up on the motor or outside air vents.
- Stop the chain saw before setting it down.
- Do not cut vines and/or small under brush.
- Use extreme caution when cutting small size brush and saplings because slender material may catch the saw chain and be whipped toward you or pull you off balance.



WARNING: Some dust created by power sanding, sawing, grinding, drilling, and other construction activities contains chemicals known to the State of California to cause cancer, birth defects or other reproductive harm. Some examples of these chemicals are:

- lead from lead-based paints,
- crystalline silica from bricks and cement and other masonry products, and
- arsenic and chromium from chemically-treated lumber.

Your risk from these exposures varies, depending on how often you do this type of work. To reduce your exposure to these chemicals: work in a well ventilated area, and work with approved safety equipment, such as those dust masks that are specially designed to filter out microscopic particles.

- Avoid prolonged contact with dust from power sanding, sawing, grinding, drilling, and other construction activities. Wear protective clothing and wash exposed areas with soap and water. Allowing dust to get into your mouth, eyes, or lay on the skin may promote absorption of harmful chemicals.



WARNING: Use of this tool can generate and/or disburse dust, which may cause serious and permanent respiratory or other injury.

Chainsaw Names and Terms

- *Bucking* - The process of cross cutting a felled tree or log into lengths.
- *Motor Brake* - A device used to stop the saw chain when the trigger is released.
- *Chain Saw Powerhead* - A chain saw without the saw chain and guide bar.
- *Drive Sprocket or Sprocket* - The toothed part that drives the saw chain.
- *Felling* - The process of cutting down a tree.
- *Felling Back Cut* - The final cut in a tree felling operation made on the opposite side of the tree from the notching cut.
- *Front Handle* - The support handle located at or toward the front of the chain saw.
- *Front Hand Guard* - A structural barrier between the front handle of a chain saw and the guide bar, typically located close to the hand position on the front handle.
- *Guide Bar* - A solid railed structure that supports and guides the saw chain.
- *Guide Bar Scabbard* - Enclosure fitted over guide bar to prevent tooth contact when saw is not in use.

- *Kickback* - The backward or upward motion, or both of the guide bar occurring when the saw chain near the nose of the top area of the guide bar contacts any object such as a log or branch, or when the wood closes in and pinches the saw chain in the cut.
- *Kickback, Pinch* - The rapid pushback of the saw which can occur when the wood closes in and pinches the moving saw chain in the cut along the top of the guide bar.
- *Kickback, Rotational* - The rapid upward and backward motion of the saw which can occur when the moving saw chain near the upper portion of the tip of the guide bar contacts an object, such as a log or branch.
- *Limbing* - Removing the branches from a fallen tree
- *Low-Kickback Chain* - A chain that reduces the kickback performance requirements. (when tested on a representative sample of chain saws.)
- *Normal Cutting Position* - Those positions assumed in performing the bucking and felling cuts.
- *Notching Undercut* - A notch cut in a tree that directs the tree's fall.
- *Rear Handle* - The support handle located at or toward the rear of the saw.
- *Reduced Kickback Guide Bar* - A guide bar which has been demonstrated to reduce kickback significantly.
- *Replacement Saw Chain* - A chain that reduces the kickback performance requirements when tested with specific chain saws.
- *Saw Chain* - A loop of chain having cutting teeth, that cut the wood, and that is driven by the motor and is supported by the guide bar.
- *Ribbed Bumper* - The ribs used when felling or bucking to pivot the saw and maintain position while sawing.
- *Switch* - A device that when operated will complete or interrupt an electrical power circuit to the motor of the chain saw.
- *Switch Linkage* - The mechanism that transmits motion from a trigger to the switch.
- *Switch Lockout* - A movable stop that prevents the unintentional operation of the switch until manually actuated.

Intended Use

Your DEWALT DCM575 Chainsaw is ideal for pruning applications and cutting logs up to 35 cm in diameter.

Residual Risks

In spite of the application of the relevant safety regulations and the implementation of safety devices, certain residual risks cannot be avoided. These are:

- *Impairment of hearing.*
- *Risk of personal injury due to flying particles.*
- *Risk of burns due to accessories becoming hot during operation.*
- *Risk of personal injury due to prolonged use.*

Electrical Safety

The electric motor has been designed for one voltage only. Always check that the battery pack voltage corresponds to the

voltage on the rating plate. Also make sure that the voltage of your charger corresponds to that of your mains.



Your DEWALT charger is double insulated in accordance with IEC60335; therefore no earth wire is required.

If the supply cord is damaged, it must be replaced by a specially prepared cord available through the DEWALT service organisation.

SAVE THESE INSTRUCTIONS

Chargers

DEWALT chargers require no adjustment and are designed to be as easy as possible to operate.

Important Safety Instructions for All Battery Chargers

SAVE THESE INSTRUCTIONS: This manual contains important safety and operating instructions for compatible battery chargers (refer to **Technical Data**).

- Before using charger, read all instructions and cautionary markings on charger, battery pack, and product using battery pack.



WARNING: Shock hazard. Do not allow any liquid to get inside charger. Electric shock may result.



WARNING: We recommend the use of a residual current device with a residual current rating of 30mA or less.



CAUTION: Burn hazard. To reduce the risk of injury, charge only DEWALT rechargeable batteries. Other types of batteries may burst causing personal injury and damage.



CAUTION: Children should be supervised to ensure that they do not play with the appliance.

NOTICE: Under certain conditions, with the charger plugged into the power supply, the exposed charging contacts inside the charger can be shorted by foreign material. Foreign materials of a conductive nature such as, but not limited to, steel wool, aluminum foil or any buildup of metallic particles should be kept away from charger cavities. Always unplug the charger from the power supply when there is no battery pack in the cavity. Unplug charger before attempting to clean

- **DO NOT attempt to charge the battery pack with any chargers other than the ones in this manual.** The charger and battery pack are specifically designed to work together.
- **These chargers are not intended for any uses other than charging DEWALT rechargeable batteries.** Any other uses may result in risk of fire, electric shock or electrocution.
- **Do not expose charger to rain or snow.**
- **Pull by plug rather than cord when disconnecting charger.** This will reduce risk of damage to electric plug and cord.
- **Make sure that cord is located so that it will not be stepped on, tripped over, or otherwise subjected to damage or stress.**

- **Do not use an extension cord unless it is absolutely necessary.** Use of improper extension cord could result in risk of fire, electric shock, or electrocution.
- **Do not place any object on top of charger or place the charger on a soft surface that might block the ventilation slots and result in excessive internal heat.** Place the charger in a position away from any heat source. The charger is ventilated through slots in the top and the bottom of the housing.
- **Do not operate charger with damaged cord or plug—** have them replaced immediately.
- **Do not operate charger if it has received a sharp blow, been dropped, or otherwise damaged in any way.** Take it to an authorised service centre.
- **Do not disassemble charger; take it to an authorised service centre when service or repair is required.** Incorrect reassembly may result in a risk of electric shock, electrocution or fire.
- In case of damaged power supply cord the supply cord must be replaced immediately by the manufacturer, its service agent or similar qualified person to prevent any hazard.
- **Disconnect the charger from the outlet before attempting any cleaning. This will reduce the risk of electric shock.** Removing the battery pack will not reduce this risk.
- **NEVER** attempt to connect two chargers together.
- **The charger is designed to operate on standard 220-240V household electrical power. Do not attempt to use it on any other voltage.** This does not apply to the vehicular charger.

Charging a Battery (Fig. B)

1. Plug the charger into an appropriate outlet before inserting battery pack.
2. Insert the battery pack **7** into the charger, making sure the battery pack is fully seated in the charger. The red (charging) light will blink repeatedly indicating that the charging process has started.
3. The completion of charge will be indicated by the red light remaining ON continuously. The battery pack is fully charged and may be used at this time or left in the charger. To remove the battery pack from the charger, push the battery release button **15** on the battery pack.

NOTE: To ensure maximum performance and life of lithium-ion battery packs, charge the battery pack fully before first use.

Charger Operation

Refer to the indicators below for the charge status of the battery pack.

Charge Indicators		
	Charging	
	Fully Charged	
	Hot/Cold Pack Delay*	

*The red light will continue to blink, but a yellow indicator light will be illuminated during this operation. Once the battery pack has reached an appropriate temperature, the yellow light will turn off and the charger will resume the charging procedure.

The compatible charger(s) will not charge a faulty battery pack. The charger will indicate faulty battery by refusing to light or by displaying problem pack or charger blink pattern.

NOTE: This could also mean a problem with a charger.

If the charger indicates a problem, take the charger and battery pack to be tested at an authorised service centre.

Hot/Cold Pack Delay

When the charger detects a battery pack that is too hot or too cold, it automatically starts a Hot/Cold Pack Delay, suspending charging until the battery pack has reached an appropriate temperature. The charger then automatically switches to the pack charging mode. This feature ensures maximum battery pack life.

A cold battery pack will charge at a slower rate than a warm battery pack. The battery pack will charge at that slower rate throughout the entire charging cycle and will not return to maximum charge rate even if the battery pack warms.

The DCB118 charger is equipped with an internal fan designed to cool the battery pack. The fan will turn on automatically when the battery pack needs to be cooled. Never operate the charger if the fan does not operate properly or if ventilation slots are blocked. Do not permit foreign objects to enter the interior of the charger.

Electronic Protection System

XR Li-Ion tools are designed with an Electronic Protection System that will protect the battery pack against overloading, overheating or deep discharge.

The tool will automatically turn off if the Electronic Protection System engages. If this occurs, place the lithium-ion battery pack on the charger until it is fully charged.

Wall Mounting

These chargers are designed to be wall mountable or to sit upright on a table or work surface. If wall mounting, locate the charger within reach of an electrical outlet, and away from a corner or other obstructions which may impede air flow. Use the back of the charger as a template for the location of the mounting screws on the wall. Mount the charger securely using drywall screws (purchased separately) at least 25.4 mm long with a screw head diameter of 7–9 mm, screwed into wood to an optimal depth leaving approximately 5.5 mm of the screw exposed. Align the slots on the back of the charger with the exposed screws and fully engage them in the slots.

Charger Cleaning Instructions



WARNING: Shock hazard. Disconnect the charger from the AC outlet before cleaning. Dirt and grease may be removed from the exterior of the charger using a cloth or soft non-metallic brush. Do not use water or any cleaning solutions. Never let any liquid get inside the tool; never immerse any part of the tool into a liquid.

Battery Packs

Important Safety Instructions for All Battery Packs

When ordering replacement battery packs, be sure to include catalogue number and voltage.

The battery pack is not fully charged out of the carton. Before using the battery pack and charger, read the safety instructions below. Then follow charging procedures outlined.

READ ALL INSTRUCTIONS

- **Do not charge or use battery in explosive atmospheres, such as in the presence of flammable liquids, gases or dust.** Inserting or removing the battery from the charger may ignite the dust or fumes.
- **Never force battery pack into charger. Do not modify battery pack in any way to fit into a non-compatible charger as battery pack may rupture causing serious personal injury.**
- Charge the battery packs only in DeWALT chargers.
- **DO NOT splash or immerse in water or other liquids.**
- **Do not store or use the tool and battery pack in locations where the temperature may reach or exceed 40 °C (104 °F) (such as outside sheds or metal buildings in summer).**
- **Do not incinerate the battery pack even if it is severely damaged or is completely worn out.** The battery pack can explode in a fire. Toxic fumes and materials are created when lithium-ion battery packs are burned.
- **If battery contents come into contact with the skin, immediately wash area with mild soap and water.** If battery liquid gets into the eye, rinse water over the open eye for 15 minutes or until irritation ceases. If medical attention is needed, the battery electrolyte is composed of a mixture of liquid organic carbonates and lithium salts.
- **Contents of opened battery cells may cause respiratory irritation.** Provide fresh air. If symptoms persists, seek medical attention.



WARNING: Burn hazard. Battery liquid may be flammable if exposed to spark or flame.



WARNING: Never attempt to open the battery pack for any reason. If battery pack case is cracked or damaged, do not insert into charger. Do not crush, drop or damage battery pack. Do not use a battery pack or charger that has received a sharp blow, been dropped, run over or damaged in any way (i.e., pierced with a nail, hit with a hammer, stepped on). Electric shock or electrocution may result. Damaged battery packs should be returned to service centre for recycling.



WARNING: Fire hazard. Do not store or carry the battery pack so that metal objects can contact exposed battery terminals. For example, do not place the battery pack in aprons, pockets, tool boxes, product kit boxes, drawers, etc., with loose nails, screws, keys, etc.



CAUTION: When not in use, place tool on its side on a stable surface where it will not cause a tripping

or falling hazard. Some tools with large battery packs will stand upright on the battery pack but may be easily knocked over.

Transportation



WARNING: Fire hazard. Transporting batteries can possibly cause fire if the battery terminals inadvertently come in contact with conductive materials. When transporting batteries, make sure that the battery terminals are protected and well insulated from materials that could contact them and cause a short circuit.

DeWALT batteries comply with all applicable shipping regulations as prescribed by industry and legal standards which include UN Recommendations on the Transport of Dangerous Goods; International Air Transport Association (IATA) Dangerous Goods Regulations, International Maritime Dangerous Goods (IMDG) Regulations, and the European Agreement Concerning The International Carriage of Dangerous Goods by Road (ADR). Lithium-ion cells and batteries have been tested to section 38.3 of the UN Recommendations on the Transport of Dangerous Goods Manual of Tests and Criteria.

In most instances, shipping a DeWALT battery pack will be excepted from being classified as a fully regulated Class 9 Hazardous Material. In general, only shipments containing a lithium-ion battery with an energy rating greater than 100 Watt Hours (Wh) will require being shipped as fully regulated Class 9. All lithium-ion batteries have the Watt Hour rating marked on the pack. Furthermore, due to regulation complexities, DeWALT does not recommend air shipping lithium-ion battery packs alone regardless of Watt Hour rating. Shipments of tools with batteries (combo kits) can be air shipped as excepted if the Watt Hour rating of the battery pack is no greater than 100 Whr. Regardless of whether a shipment is considered excepted or fully regulated, it is the shipper's responsibility to consult the latest regulations for packaging, labeling/marketing and documentation requirements.

The information provided in this section of the manual is provided in good faith and believed to be accurate at the time the document was created. However, no warranty, expressed or implied, is given. It is the buyer's responsibility to ensure that its activities comply with the applicable regulations.

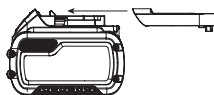
Transporting the FLEXVOLT™ Battery

The DeWALT FLEXVOLT™ battery has two modes: **Use** and **Transport**.

Use Mode: When the FLEXVOLT™ battery stands alone or is in a DeWALT 18V(20V Max) product, it will operate as an 18V(20V Max) battery. When the FLEXVOLT™ battery is in a 54V(60V Max) or a 108V(120V Max) (two 54V(60V Max) batteries) product, it will operate as a 54V(60V Max) battery.

Transport Mode: When the cap is attached to the FLEXVOLT™ battery, the battery is in Transport mode. Keep the cap for shipping.

When in Transport mode, strings of cells are electrically disconnected within the pack resulting in 3 batteries with a



lower Watt hour (Wh) rating as compared to 1 battery with a higher Watt hour rating. This increased quantity of 3 batteries with the lower Watt hour rating can exempt the pack from certain shipping regulations that are imposed upon the higher Watt hour batteries.

For example, the Transport Wh rating might indicate 3 x 36 Wh, meaning 3 batteries of 36 Wh each.

The Use Wh rating might indicate 108 Wh (1 battery implied).



Use: 108 Wh

Transport: 3x36 Wh

Storage Recommendations

1. The best storage place is one that is cool and dry away from direct sunlight and excess heat or cold. For optimum battery performance and life, store battery packs at room temperature when not in use.
2. For long storage, it is recommended to store a fully charged battery pack in a cool, dry place out of the charger for optimal results.

NOTE: Battery packs should not be stored completely depleted of charge. The battery pack will need to be recharged before use.

Labels on Charger and Battery Pack

In addition to the pictographs used in this manual, the labels on the charger and the battery pack may show the following pictographs:



Read instruction manual before use.



See **Technical Data** for charging time.



Do not probe with conductive objects.



Do not charge damaged battery packs.



Do not expose to water.



Have defective cords replaced immediately.



Charge only between 4 °C and 40 °C.



Only for indoor use.



Discard the battery pack with due care for the environment.

LI-ION



Charge DeWALT battery packs only with designated DeWALT chargers. Charging battery packs other than the designated DeWALT batteries with a DeWALT charger may make them burst or lead to other dangerous situations.



Do not incinerate the battery pack.



USE (without transport cap). Example: Wh rating indicates 108 Wh (1 battery with 108 Wh).



TRANSPORT (with built-in transport cap). Example: Wh rating indicates 3 x 36 Wh (3 batteries of 36 Wh).

Battery Type

The DCM575 operates on a 54(60 Max) volt battery pack.

These battery packs may be used: DCB546, DCB547, DCB548, DCB606, DCB609, DCB612. Refer to **Technical Data** for more information.

Package Contents

The package contains:

- 1 Chainsaw
- 1 Scabbard
- 1 Bar 40 cm
- 1 Chain 40 cm
- 1 Instruction manual

NO BATTERY OR CHARGER INCLUDED

- 1 Li-Ion battery pack**
- 1 Li-Ion battery charger**

**Included with DCM575X1 Only

- Check for damage to the tool, parts or accessories which may have occurred during transport.
- Take the time to thoroughly read and understand this manual prior to operation.

Markings on Tool

The following pictograms are shown on the tool:



Read instruction manual before use.



Wear ear protection.



Wear eye protection.



Do not leave in rain.



Tip contact can cause the guide bar to move suddenly upward and backward, which can cause serious injury.



Contact of the guide bar tip with any object should be avoided.



Rotational direction of the saw chain.



Always use two hands when operating the chainsaw.



Switch the tool off. Before performing any maintenance on the tool, remove the battery from the tool.

Date Code Position

The date code, which also includes the year of manufacture, is printed into the housing.

Example:

2021 XX XX

Year of Manufacture

Description (Fig. A)



WARNING: Never modify the power tool or any part of it. Damage or personal injury could result.

- 1 Variable speed trigger switch
- 2 Lock-off lever
- 3 Chain brake / front hand guard
- 4 Guide bar
- 5 Saw chain
- 6 Sprocket cover
- 7 Battery Pack
- 8 Bar adjust locking knob
- 9 Chain tensioning knob
- 10 Oil level indicator
- 11 Guide bar scabbard
- 12 Rear handle
- 13 Front handle
- 14 Battery housing
- 15 Battery release button
- 16 Oil cap (not shown)

Intended Use

Your chainsaw has been designed for professional cutting applications.

DO NOT use under wet conditions or in the presence of flammable liquids or gases.

This chainsaw is a professional power tool.

DO NOT let children come into contact with the tool.

Supervision is required when inexperienced operators use this tool.

- **Young children and the infirm.** This appliance is not intended for use by young children or infirm persons without supervision.
- This product is not intended for use by persons (including children) suffering from diminished physical, sensory or mental abilities; lack of experience, knowledge or skills unless they are supervised by a person responsible for their safety. Children should never be left alone with this product.

ASSEMBLY AND ADJUSTMENTS



WARNING: To reduce the risk of serious personal injury, turn tool off and disconnect battery pack before making any adjustments or removing/installing attachments or accessories. An accidental start-up can cause injury.



WARNING: Use only DEWALT battery packs and chargers.

Inserting and Removing the Battery Pack from the Tool (Fig. C–E)

NOTE: Make sure your battery pack 7 is fully charged.

To Install the Battery Pack into the Tool

1. Align the battery pack 7 with the rails inside the tool (Fig. C).
2. Slide it into the tool until the battery pack is firmly seated and ensure that you hear the lock snap into place.

To Remove the Battery Pack from the Tool

1. Press the release button 15 and firmly pull the battery pack out of the tool handle (Fig. D).
2. Insert battery pack into the charger as described in the charger section of this manual.

Fuel Gauge Battery Packs (Fig. E)

Some DEWALT battery packs include a fuel gauge which consists of three green LED lights that indicate the level of charge remaining in the battery pack.

To actuate the fuel gauge, press and hold the fuel gauge button 17. A combination of the three green LED lights will illuminate designating the level of charge left. When the level of charge in the battery is below the usable limit, the fuel gauge will not illuminate and the battery will need to be recharged.

NOTE: The fuel gauge is only an indication of the charge left on the battery pack. It does not indicate tool functionality and is subject to variation based on product components, temperature and end-user application.

ASSEMBLY

Installing the Guide Bar and Saw Chain (Fig. A, F–H, K)



CAUTION: Sharp chain. Always wear protective gloves when handling the chain. The chain is sharp and can cut you when it is not running.



WARNING: Sharp moving chain. To prevent accidental operation, ensure that battery is removed from the tool before performing the following operations. Failure to do this could result in serious personal injury.

The saw chain 5 and guide bar 4 are packed separately in the carton. The chain has to be attached to the bar, and both must be attached to the body of the tool.

- Place the saw on a flat, firm surface.
- Flip up locking lever and rotate the bar adjust locking knob 8 counterclockwise as shown in Figure F to remove sprocket cover 6.

- Wearing protective gloves, grasp the saw chain 5 and wrap it around the guide bar 4, ensuring the teeth are facing the correct direction (see Figure K)
- Ensure the chain is properly set in the slot around the entire guide bar.
- Place the saw chain around the sprocket 18. While lining up the slot on the guide bar with chain tensioning pin 20, and the bolt 19, on the base of the tool as shown in Figure G.
- Once in place, hold the bar still, replace sprocket cover 6. Make sure tool-free tension assembly bolt hole on the cover lines up with the bolt 19, in the main housing. Flip up locking lever and rotate the bar adjust locking knob 8 clockwise until snug, then loosen knob one full turn, so that the saw chain can be properly tensioned.
- Rotate the chain tensioning knob 9 clockwise to increase tension as shown in Figure H. Make sure the saw chain 5 is snug around the guide bar 4. Tighten the bar adjust locking knob 8 until snug.

Adjusting Chain Tension (Fig. A, I)



CAUTION: Sharp chain. Always wear protective gloves when handling the chain. The chain is sharp and can cut you when it is not running.



WARNING: Sharp moving chain. To prevent accidental operation, ensure that battery is removed from the tool before performing the following operations. Failure to do this could result in serious personal injury.

- With the saw on a flat, firm surface, check the saw chain 5 tension. The tension is correct when the chain snaps back after being pulled 3 mm away from the guide bar 4 with light force from the index finger and thumb as shown in Figure I. There should be no “sag” between the guide bar and the chain on the underside as shown in Figure I.
- To adjust saw chain tension, flip up locking tab and rotate the bar adjust locking knob 8 counterclockwise one full turn. Rotate the chain tensioning knob 9 clockwise until the chain tension is correct as instructed above.
- Do not over-tension the chain as this will lead to excessive wear and will reduce the life of the bar and chain.
- Once chain tension is correct, securely tighten bar adjust locking knob.
- When the chain is new, check the tension frequently (after removing battery) during the first 2 hours of use as a new chain stretches slightly.

Replacing the Saw Chain (Fig. A, K)



CAUTION: Sharp chain. Always wear protective gloves when handling the chain. The chain is sharp and can cut you when it is not running.



WARNING: Sharp moving chain. To prevent accidental operation, ensure that battery is removed from the tool before performing the following operations. Failure to do this could result in serious personal injury.

- Flip up locking tab and rotate the bar adjust locking knob 8 counterclockwise to release chain tension.

- Remove sprocket cover **6** as described in *Installing the Guide Bar and Saw Chain* section.
- Lift the front saw chain **5** out of the groove in the guide bar **4**.
- Place the new chain in the slot of the guide bar, making sure the saw teeth are facing the correct direction by matching the arrow on the chain with the graphic on the sprocket cover **6** shown in Figure K.
- Follow instructions for *Installing the Guide Bar and Saw Chain*.

Replacement chain and bar are available from your nearest DEWALT service center.

- DCM575 requires replacement chain # DWRC1600, service part number N594321. Replacement 40 cm bar, service part number N594320.

Saw Chain and Guide Bar Oiling (Fig. L) Auto Oiling System

This chain saw is equipped with an auto oiling system that keeps the saw chain and guide bar constantly lubricated. The oil level indicator **10** shows the level of the oil in the chain saw. If the oil level is less than a quarter full, remove the battery from the chain saw and refill with the correct type of oil. Always empty oil tank when finished cutting.

NOTE: Use a high quality bar and chain oil for proper chain and bar lubrication. As a temporary substitute, a non-detergent SAE30 weight motor oil can be used. The use of a vegetable based bar and chain oil is recommended when pruning trees. Mineral oil is not recommended because it may harm trees. Never use waste oil or very thick oil. These may damage your chain saw.

Filling the Oil Reservoir

- Flip down locking lever and unscrew counterclockwise a quarter turn and then remove the oil cap **16**. Fill the reservoir with the recommended bar and chain oil until the oil level has reached the top of the oil level indicator **10**.
- Refit the oil cap and tighten clockwise a quarter turn. Flip up locking lever to its locked position.
- Periodically switch the chain saw off and check the oil level indicator to ensure the bar and chain are being properly oiled.

Transporting Saw (Fig. A, M)

- Always remove the battery from the tool and cover the guide bar **4** with the scabbard **11** (Figure M) when transporting the saw.
- Engage chain brake by pushing chain brake / front hand guard **3** forward.

OPERATION

Instructions for Use



WARNING: Always observe the safety instructions and applicable regulations.



WARNING: To reduce the risk of serious personal injury, turn tool off and disconnect battery pack before making any adjustments or removing/ installing attachments or accessories. An accidental start-up can cause injury.

Proper Hand Position (Fig. A, J)



WARNING: To reduce the risk of serious personal injury, ALWAYS use proper hand position as shown.



WARNING: To reduce the risk of serious personal injury, ALWAYS hold securely in anticipation of a sudden reaction.

Proper hand position requires the left hand on the front handle **13**, with the right hand on the rear handle **12**.

Operating the Chain Saw (Fig. A, N–O)



WARNING: Read and understand all instructions. Failure to follow all instructions listed below may result in electric shock, fire and/or serious personal injury.

- Guard Against Kickback which can result in severe injury or death. See Important Safety Instructions Guard Against Kickback, to avoid the risk of kickback.
- Do not overreach. Do not cut above chest height. Make sure your footing is firm. Keep feet apart. Divide your weight evenly on both feet.
- Use a firm grip with your left hand on the front handle **13** and your right hand on the rear handle **12** so that your body is to the left of the guide bar.
- Do not hold chain saw by front hand guard/ chain brake **3**. Keep elbow of left arm locked so that left arm is straight to withstand a kickback.



WARNING: Never use a cross-handed grip (left hand on the rear handle and right hand on the front handle).



WARNING: Never allow any part of your body to be in line with the guide bar **4** when operating the chain saw.

- Never operate while in a tree, in any awkward position or on a ladder or other unstable surface. You may lose control of saw causing severe injury.
- Keep the chain saw running at full speed the entire time you are cutting.
- Allow the chain to cut for you. Exert only light pressure. Do not put pressure on chain saw at end of cut.



WARNING: When not in use always have the chain brake engaged and battery removed.

On / Off Switch

Always be sure of your footing and grip the chain saw firmly with both hands with the thumb and fingers encircling both handles.

This tool is equipped with a variable speed trigger switch. To turn the unit on, ensure chain brake is not engaged. Push down on the lock off lever **2**, shown in Figure N, and squeeze the trigger switch **1**. Once the unit is running, you may release the lock off lever. The farther you depress the trigger, the faster it will operate.

In order to keep the unit running you must continue to squeeze the trigger. To turn the unit off, release the trigger.

NOTE: If too much force is applied while making a cut the saw will turn off. To restart saw, you must release the lock off lever **2** and the trigger switch **1** before the saw will restart. Begin your cut again this time with less force. Allow the saw to cut at its own pace.

WARNING: *Never attempt to lock a switch in the ON position.*

Setting The Chain Brake

Your chain saw is equipped with a motor chain braking system which will stop the chain quickly in case of kickback.

- Remove the battery from the tool.
- To engage the chain brake, push the chain brake / front hand guard **3** forward until it clicks into place.
- Pull the chain brake / front hand guard **3** towards the front handle **13** into the "set" position as shown in Figure O.
- The tool is now ready to use.

NOTE: In the event of kickback, your left hand will come in contact with the front guard, pushing it forward, toward the workpiece. This will stop the tool.

Testing The Chain Brake

Test the chain brake before every use to make sure it operates correctly.

- Place the tool on a flat, firm surface. Make sure the saw chain **5** is clear of the ground.
- Grip the tool firmly with both hands and turn the chain saw on.
- Rotate your left hand forward around the front handle **13** so the back of your hand comes in contact with the Chain brake / front hand guard **3** and push it forward, toward the workpiece. The saw chain should stop immediately.

NOTE: If saw does not stop immediately, stop use of tool and bring it to a DEWALT service center nearest you.

WARNING: *Make sure to set chain brake before cutting.*

Common Cutting Techniques (Fig. A, P, Q, U, V, W)

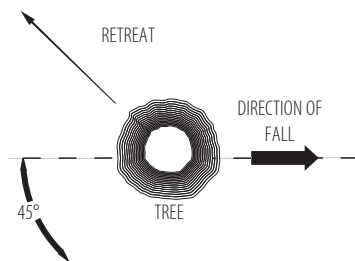
Felling

The process of cutting down a tree. Be sure battery is fully charged before felling a tree so you can finish on a single charge. Do not fell trees in high wind conditions.

WARNING: *Felling can result in injury. It should only be performed by a trained person.*

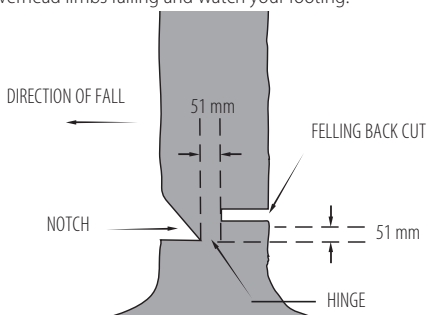
- A retreat path should be planned and cleared as necessary before cuts are started. The retreat path should extend back and diagonally to the rear of the expected line of fall. (Figure U)

Fig. U



- Before felling is started, consider the natural lean of the tree, the location of larger branches and the wind direction to judge which way the tree will fall. Have wedges (wood, plastic or aluminum) and a heavy mallet handy. Remove dirt, stones, loose bark, nails, staples, and wire from the tree where the felling cuts are to be made.
- Notching Undercut - Make the notch 1/3 of the diameter of the tree, perpendicular to the direction of the fall. Make the lower horizontal notching cut first. This will help to avoid pinching of either the saw chain or the guide bar when the second notch cut is being made (Figure V).
- Felling Back Cut - Make the felling back cut at least 51 mm higher than the horizontal notching cut. Keep the felling back cut parallel to the horizontal notching cut. Make the felling back cut so enough wood is left to act as a hinge. The hinge wood keeps the tree from twisting and falling in the wrong direction. Do not cut through the hinge (Figure V).
- As the felling cut gets close to the hinge the tree should begin to fall. If there is any chance that the tree may not fall in the desired direction or it may rock back and bind the saw chain, stop cutting before the felling cut is complete and use wedges to open the cut and drop the tree along the desired line of fall. When the tree begins to fall remove the chain saw from the cut, stop the motor, put the chain saw down, then use the retreat path planned. Be alert for overhead limbs falling and watch your footing.

Fig. V



Limbing

Removing the branches from a fallen tree. When limbing, leave larger lower limbs to support the log off the ground. Remove the small limbs in one cut. Branches under tension should be cut from the bottom of the branch towards the top to avoid binding the chain saw as shown in Figure P. Trim limbs from

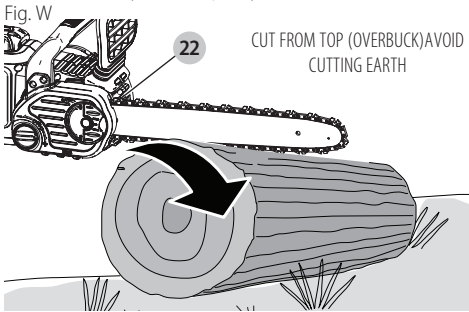
opposite side keeping tree stem between you and saw. Never make cuts with saw between your legs or straddle the limb to be cut.

Bucking

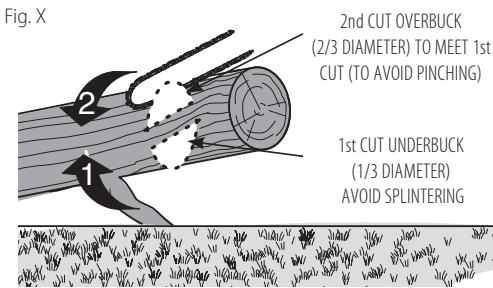
! WARNING: Recommend that first time users should practice cutting on a saw horse.

Cutting a felled tree or log into lengths. How you should cut depends on how the log is supported. Use a saw horse (Figure Q) whenever possible.

- Always start a cut with the chain running at full speed.
- Place the bottom spike **22** of the chain saw behind the area of the initial cut as shown in Figure W.
- Turn the chain saw on then rotate the chain and bar down into the tree, using the spike as a hinge.
- Once the chain saw gets to a 45 degree angle, level the chain saw again and repeat steps until you cut fully through.
- When the tree is supported along its entire length, make a cut from the top (overbuck), but avoid cutting the earth as this will dull your saw quickly.

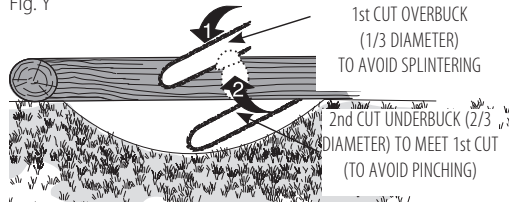


- **Figure X-** When supported at one end First, cut 1/3 the diameter from the underside (underbuck). Then make the finishing cut by overbucking to meet the first cut.



- **Figure Y-** When supported at both ends. First, cut 1/3 down from the top overbuck. Then make the finished cut by underbucking the lower 2/3 to meet the first cut.

Fig. Y



- When on a slope always stand on the uphill side of the log. When “cutting through”, to maintain complete control reduce the cutting pressure near the end of the cut without relaxing your grip on the chain saw handles. Don’t let the chain contact the ground. After completing the cut, wait for the saw chain to stop before you move the chain saw. Always stop the motor before moving from cut to cut.

CARE AND MAINTENANCE

Use only mild soap and damp cloth to clean the tool. Do not use solvents to clean the plastic housing of the saw. Never let any liquid get inside the tool; never immerse any part of the tool into a liquid.

IMPORTANT: To assure product SAFETY and RELIABILITY, repairs, maintenance and adjustment should be performed by a DEWALT authorized service center, always using identical replacement parts.

Regular maintenance ensures a long effective life for your chain saw.

Chain and Bar

After every few hours of use, remove the sprocket cover, guide bar and chain and clean thoroughly using a soft bristle brush. Ensure oiling hole on bar is clear of debris. When replacing dull chains with sharp chains it is good practice to flip the chain bar from bottom to top.

Saw Chain Sharpening (Fig. R–T)

! CAUTION: Sharp chain. Always wear protective gloves when handling the chain. The chain is sharp and can cut you when it is not running.

! WARNING: Sharp moving chain. To prevent accidental operation, ensure that battery is removed from the tool before performing the following operations. Failure to do this could result in serious personal injury.

NOTE: The cutters will dull immediately if they touch the ground or a nail while cutting.

To get the best possible performance from your chain saw it is important to keep the teeth of the chain sharp. Follow these helpful tips for proper saw chain sharpening:

1. For best results use a 4.5 mm file and a file holder or filing guide to sharpen your chain. This will ensure you always get the correct sharpening angles.
2. Place the file holder flat on the top plate and depth gauge of the cutter.
3. **Figure R-** Keep the correct top plate **21** filing angle line of 30° on your file guide parallel with your chain (file at 60° from chain viewed from the side).

- Sharpen cutters on one side of the chain first. File from the inside of each cutter to the outside. Then turn your saw around and repeat the processes (2,3,4) for cutters on the other side of the chain.

NOTE: Use a flat file to file the tops of the rakers (portion of chain link in front of the cutter) so they are about 0.635 mm below the tips of the cutters as shown in **Figure 5**.

- Figure T** - Keep all cutter lengths equal.
- If damage is present on the chrome surface of the top plates or side plates, file back until such damage is removed.

CAUTION: After filing, the cutter will be sharp, use extra caution during this process.

NOTE: Each time the chain is sharpened, it loses some of the low kickback qualities and extra caution should be used. It is recommended that a chain be sharpened no more than four times.

Accessories

WARNING: The use of accessories not recommended in this manual may be hazardous.

Replacement chain and bar are available from your nearest DEWALT authorized service center. For use only with low kick back bar and chain.

Available bars and chains for **DCM575**:

- Bar: **40 cm** service part number N594320
46 cm service part number N594315
- Chain: **40 cm** service part number N594321
46 cm service part number N594318

MAINTENANCE

Your DEWALT power tool has been designed to operate over a long period of time with a minimum of maintenance. Continuous satisfactory operation depends upon proper tool care and regular cleaning.

WARNING: To reduce the risk of serious personal injury, turn tool off and disconnect battery pack before making any adjustments or removing/installing attachments or accessories. An accidental start-up can cause injury.

The charger and battery pack are not serviceable.



Lubrication

Refer to **Saw Chain and Guide Bar Oiling** (Fig. L)



Cleaning

WARNING: Blow dirt and dust out of the main housing with dry air as often as dirt is seen collecting in and around the air vents. Wear approved eye protection and approved dust mask when performing this procedure.

WARNING: Never use solvents or other harsh chemicals for cleaning the non-metallic parts of the tool. These chemicals may weaken the materials used in these parts. Use a cloth dampened only with water and mild soap. Never let any liquid get inside the tool; never immerse any part of the tool into a liquid.

Optional Accessories

WARNING: Since accessories, other than those offered by DEWALT, have not been tested with this product, use of such accessories with this tool could be hazardous. To reduce the risk of injury, only DEWALT recommended accessories should be used with this product.

Consult your dealer for further information on the appropriate accessories.

Protecting the Environment



Separate collection. Products and batteries marked with this symbol must not be disposed of with normal household waste.



Products and batteries contain materials that can be recovered or recycled reducing the demand for raw materials. Please recycle electrical products and batteries according to local provisions. Further information is available at www.2helpU.com.

Rechargeable Battery Pack

This long life battery pack must be recharged when it fails to produce sufficient power on jobs which were easily done before. At the end of its technical life, discard it with due care for our environment:

- Run the battery pack down completely, then remove it from the tool.
- Li-Ion cells are recyclable. Take them to your dealer or a local recycling station. The collected battery packs will be recycled or disposed of properly.

After Service and Repair

DEWALT service centers are staffed with trained personnel to provide customers with efficient and reliable product service. We do not take any responsibility when you have repaired in unauthorized service center. You can refer to the leaflet of CONTACT CENTER LOCATOR in product package and contact us through hotline, website or social media to find the nearest DEWALT service center around you.

TROUBLESHOOTING

Problem	Solution
Unit will not start.	<ul style="list-style-type: none"> • Check battery installation. • Check battery charging requirements. • Check that lock off is fully pushed down prior to moving main trigger.
Unit shuts down in use.	<ul style="list-style-type: none"> • Charge battery. • Unit is being forced. Restart and apply less pressure.
Battery won't charge.	<ul style="list-style-type: none"> • Insert battery into charger until red charging light illuminates. Charge up to 8 hours if battery is totally drained. • Plug charger into a working outlet. Refer to Important Charging Notes for more details. • Check current at receptacle by plugging an appliance. • Check to see if receptacle is connected to a light switch which turns power off when you turn out the lights. • Move charger and appliance to a surrounding air temperature of above 4.5 °C or below 40.5 °C.
Bar / Chain overheated.	<ul style="list-style-type: none"> • Refer to Adjusting Chain Tension section. • Refer to Chain Oiling section.
Chain is loose.	<ul style="list-style-type: none"> • Refer to Adjusting Chain Tension section.
Poor cut quality.	<ul style="list-style-type: none"> • Refer to Adjusting Chain Tension section. NOTE: Excessive tension leads to excessive wear and reduction in life of bar and chain. Lubricate before each cut. Refer to Replacing the Saw Chain section.
Unit runs but does not cut.	<ul style="list-style-type: none"> • Chain could be installed backwards. Refer to sections for installing and removing chain.
Unit does not oil.	<ul style="list-style-type: none"> • Refill oil reservoir. • Clean guide bar, sprocket and sprocket cover. Refer to Care And Maintenance section.

60V MAX 链锯

DCM575

恭喜!

感谢您选购 DeWALT 工具。凭借多年的产品开发和创新能力，DeWALT 已经成为专业电动工具用户最可靠的合作伙伴之一。

技术参数

			DCM575
电压	V_{DC}		54 (60V Max)
电池类型			锂离子
导板长度	厘米		40
链条速度	米/秒		15
最大切割长度	厘米		40
油容量	毫升		115
重量(不含电池包)	千克		4.4

电池				充电器/充电时间(分钟)							
目录号	V_{DC}	安时	重量	DCB104	DCB107	DCB112	DCB115	DCB117	DCB118	DCB132	DCB1112
DCB546/DCB606	18/54 (20/60 Max)	6.0/2.0	1.05	60	270	170	90	40	60	90	40
DCB547/DCB609	18/54 (20/60 Max)	9.0/3.0	1.46	75*	420	270	135*	60	75*	135*	60
DCB548/DCB612	18/54 (20/60 Max)	12.0/4.0	1.44	120	540	350	180	80	120	180	80
DCB181	18 (20 Max)	1.5	0.35	22	70	45	22	22	22	22	22
DCB182/DCB204	18 (20 Max)	4.0	0.61	60/40**	185	120	60	60/40**	60/40**	60	60/40**
DCB183/DCB203	18 (20 Max)	2.0	0.40	30	90	60	30	30	30	30	30
DCB184/DCB205	18 (20 Max)	5.0	0.62	75/50**	240	150	75	75/50**	75/50**	75	75/50**
DCB185	18 (20 Max)	1.3	0.35	22	60	40	22	22	22	22	22
DCB187	18 (20 Max)	3.0	0.54	45	140	90	45	45	45	45	45
DCB189/DCB240	18 (20 Max)	4.0	0.54	60	185	120	60	60	60	60	60
DCB186	18 (20 Max)	6.0	0.95	60	270	170	90	60	60	90	60

*日期码 201811475B 或以后

**日期码 201536 或以后



警告:为降低伤害风险,请阅读使用手册。

定义:安全准则

下列定义解释了各警示词的严重程度。请仔细阅读本手册并注意这些标志。



危险:表示存在紧急危险情况,如果不加以避免,将导致死亡或严重伤害。



警告:指示潜在的危險情况,如不加以避免,可能导致死亡或严重伤害。



警告:指示潜在的危險情况,如不加以避免,可能导致轻度或中度伤害。



注意:指示不涉及人身伤害的情况,如不加以避免,可能导致财产损失。



指示有触电风险。



表示存在火灾风险。

电动工具通用安全警告



警告：请阅读所有安全警告和说明。不了解以下所列所有说明将导致电击、火灾和/或严重伤害。

保存所有警告和说明书以备查阅

警告中的术语“电动工具”指市电驱动(有线)电动工具或电池驱动(无线)电动工具。

1) 工作场地的安全

- 保持工作场地清洁和明亮。杂乱和黑暗的场地会引发事故。
- 请勿在易爆环境，如有易燃液体、气体或粉尘的环境下操作电动工具。电动工具产生的火花会点燃粉尘或气体。
- 操作电动工具时，远离儿童和旁观者。注意力不集中会使你失去对工具的控制。

2) 电气安全

- 电动工具插头必须与插座相配。绝不能以任何方式改装插头。需接地的电动工具不能使用任何转换插头。未经改装的插头和相配的插座将降低电击风险。
- 避免人体接触接地表面，如管道、散热片和冰箱。如果你身体接触接地表面会增加电击风险。
- 不得将电动工具暴露在雨中或潮湿环境中。水进入电动工具将增加电击风险。
- 不得滥用软线。绝不能用软线搬运、拉动电动工具或拔出其插头。使软线远离热源、油、锐边或运动部件。受损或缠绕的软线会增加电击风险。
- 当在户外使用电动工具时，使用适合户外使用的延长线。适合户外使用的电线将降低电击风险。
- 如果无法避免在潮湿环境下操作电动工具，应使用带有剩余电流装置(RCD)保护的电源。RCD的使用可降低电击风险。

3) 人身安全

- 保持警觉，当操作电动工具时关注所从事的操作并保持清醒。当你感到疲倦，或在有药物、酒精或治疗反应时，不要操作电动工具。在操作电动工具时瞬间的疏忽会导致严重人身伤害。
- 使用个人防护装置。始终佩戴护目镜。防护装置，诸如适当条件下使用防尘面具、防滑安全鞋、安全帽、听力防护等装置能减少人身伤害。
- 防止意外启动。在连接电源和/或电池盒、拿起或搬运工具前确保开关处于关断位置。手指放在开关上搬运工具或开关处于接通时通电会导致危险。
- 在电动工具接通之前，拿掉所有调节钥匙或扳手。遗留在电动工具旋转零件上的扳手或钥匙会导致人员受伤。
- 请勿让手过分伸展。时刻注意立足点和身体平衡。这样能在意外情况下能更好地控制住电动工具。
- 着装适当。请勿穿宽松衣服或佩戴饰品。让你的头发、衣服和手套远离运动部件。宽松衣服、配饰或长发可能会卷入运动部件。
- 如果提供了与排屑、集尘设备连接用的装置，要确保其连接完好且使用得当。使用集尘装置可降低尘屑引起的危险。
- 不要因为频繁使用工具而产生的熟悉感而掉以轻心，忽视工具的安全准则。某个粗心的动作可能在瞬间导致严重的伤害。

4) 电动工具使用和注意事项

- 请勿勉强使用电动工具。根据用途使用合适的电动工具。选用合适的按照额定值设计的电动工具会使你工作更有效、更安全。
- 如果开关不能接通或关断电源，则不能使用该电动工具。不能通过开关来控制的电动工具是危险的且必须进行修理。
- 在进行任何调节、更换附件或存放电动工具前，必须从电源上拔掉插头和/或卸下电池包。这种防护性的安全措施降低了电动工具意外启动的风险。
- 将闲置不用的电动工具存放在儿童所及范围之外，并且不允许不熟悉电动工具和不了解这些说明的人操作电动工具。电动工具在未经理培训的使用者手中是危险的。
- 维护电动工具检查运动部件是否调整到位或卡住，检查零件破损情况和影响电动工具运行的其他状况。如有损坏，应在使用前修理好电动工具。许多事故是由维护不良的电动工具引发的。
- 保持切削刀具锋利和清洁。维护良好地有锋利切削刃的刀具不易卡住而且容易控制。
- 按照使用说明书，并考虑作业条件和要进行的作业来选择电动工具、附件和工具的刀头等。将电动工具用于那些与其用途不符的操作可能会导致危险情况。
- 保持手柄和握持表面干燥、清洁，不得沾有油脂。在意外的情况下，湿滑的手柄不能保证握持的安全和对工具的控制。

5) 电池式工具使用和注意事项

- 仅使用生产者规定的充电器充电。将适用于某种电池包的充电器用到其他电池包时可能会发生火灾危险。
- 仅使用配有专用电池包的电动工具。使用其他电池包可能会产生伤害和火灾危险。
- 当电池包不用时，将它远离其他金属物体，例如回形针、硬币、钥匙、钉子、螺钉或其他小金属物体，以防电池包一端与另一端连接。电池包端部短路会引起燃烧或火灾。
- 在滥用条件下，液体可能会从电池包中溅出，应避免接触。如果意外碰到液体，用水冲洗。如果液体碰到了眼睛，还要寻求医疗帮助。从电池中溅出的液体可能会发生腐蚀或燃烧。
- 请勿使用损坏或改装过的电池包或工具。损坏或改装过的电池包可能呈现无法预测的结果，导致火灾、爆炸或伤害。
- 请勿将电池包暴露于火或者高温中。电池包暴露于明火或高于 130 °C 的高温中可能导致爆炸。
- 请遵循所有充电说明，请勿在说明中规定的温度范围以外的环境对电池包或工具充电。不当或在指定范围以外的温度下充电，可能导致电池损坏并增加火灾风险。

6) 维修

- 让专业维修人员使用相同的备件维修电动工具。这将保证所维修的电动工具的安全。
- 不得维修损坏的电池包。电池包仅能由生产者或其授权的维修服务商进行维修。

链锯安全警告：

- 操作链锯时，让身体所有部位远离链锯。在启动链锯之前，确保链锯没有接触其他物件。操作链锯时不小心，就会将衣服或身体缠入锯链。
- 始终用右手握持链锯的后手柄，左手握持前手柄。反手握持链锯，会增加人身伤害的风险，应绝对禁止。

- **佩戴安全眼镜和听力保护器。**建议进一步提供头、手、腿和脚的**防护装备**。充分的防护衣可降低飞溅或意外触碰链锯导致的人身伤害。
- **不要站在树上操作链锯。**上树操作链锯会造成人身伤害。
- **始终保持良好的立足之地，并只有站在牢固、安全和平坦地面上时才操作链锯。**易滑或不稳的地面，诸如梯子会引起失去平衡或链锯操作失控。
- **锯割处于拉紧状态的枝杈时要提防反弹。**当木材纤维的拉力一旦释放，有弹性的树杈可能会击到操作者和/或致使链锯失控。
- **锯割灌木和小树苗时要特别当心。**细条可能会夹住链锯并向操作者打来或拉操作者失去平衡。
- **用前手柄携带关闭的链锯并使得链锯远离你的身体。**当运输或储存链锯时应始终装有**导板护罩**。适当安放链锯将降低偶然碰到运动链锯的可能性。
- **按照说明书进行润滑、张紧链锯和更换附件。**不当张紧或润滑链锯可能会断裂或者增加反弹的可能性。
- **保持手柄干燥、清洁并远离油和油脂。**油腻的手柄会打滑并引起失控。
- **只锯割木材。不能将链锯用于其他目的。**例如：不能用链锯锯割塑料、石料或非木质建筑材料。用链锯做非预期的操作会引起危险。

反弹原因和操作者防护：

当导板的前端或顶部碰到物体时，或当锯割时木材并拢而夹住链锯时可能会产生反弹。

某些情况下顶部接触会产生突然的反作用力，将导板上和向后甩向操作者。

沿导板顶部夹住链锯会快速地将导板反推向操作者。

这些反作用力中每一种都会引起导致严重人身伤害的链锯失控。不要仅仅依赖链锯内设置的安全装置。作为链锯使用者，应该采取多种步骤来保证锯割作业不发生事故或伤害。

工具的误用和/或不正确的操作程序或条件是导致反弹的原因，并可采取以下给出的预防措施来避免：

- **保持稳固的握持，用拇指和其他手指握住链锯手柄，用握持链锯的两只手，定位好你的身体和手臂以便你能承受住反弹力。**如果采取适当的预防措施，反弹力是可以被操作者控制的。不用听任链锯运转。
- **手不要伸得过长且不要在肩部以上进行锯割。**这有助于防止意外的顶部接触，并能更好地在意外情况下控制链锯。
- **仅适用制造商规定的更换导板和链条。**不正确的导板和链条可能会导致断链和/或反弹。
- **遵守制造商关于链锯的刃和维护说明。**减小深度规高度可导致反弹增加。

一般性链锯安全警告

- 在清除卡住的材料，存放或维修链锯时，请遵循所有的说明。请确保关闭开关并取下电池包。**在清除卡住的材料或维修时，链锯意外启动，可能会造成严重的人身伤害。
- 建议初次使用者，最低限度应在锯木架或支架上练习锯割原木。**

应遵循以下预防措施，将回弹的可能性降到最低：

- 请握紧电链锯。**当电机在运转时，请**双手握紧电链锯。握紧工具，让大拇指和其他手指环绕链锯手柄。**当用导板下侧切割时，电链锯会被向前拉动；当用导板上侧切割时，电链锯会被向后推动。
- 请勿让手过分伸展。**
- 时刻注意立足点和身体平衡。**
- 请勿让导板前端触碰到原木、枝干、地面或其他障碍。**
- 请勿在高于肩膀的位置进行切割。**
- 请使用设备，例如低回弹链锯和降低回弹导板，能够降低与回弹相关的风险。**
- 仅使用原厂或同等机构指定的更换杆和链锯。**
- 不得让转动的链锯接触到导板尖端的任何物体。**
- 请让工作区内没有任何障碍，例如其他的树木、枝条、岩石、栅栏、树墩等。**在切割某根原木或枝条时，请清除或避开链锯可能碰触到的任何障碍。
- 请让链锯保持锋利且处于合适的紧绷状态。松弛或钝化的链锯会增加回弹的可能性。**请定期检查紧绷情况（关闭电机并切断工具电源），不得在电机运行的情况下进行此项操作。
- 只可在链锯全速运转的情况下才能开始并继续切割。**如果链锯转速较低，则出现回弹的可能性更高。
- 一次只可切割一根原木。**
- 在重新进入原先的切口时，请极度小心。**先将肋条凸起插入木材，同时让链锯全速运转，再开始切割。
- 请勿试图进行潜入式切割或钻孔切割。**
- 请注意移动原木或可能闭合切口、挤压或落入链锯的其他作用力。**

回弹安全性的功能



警告：您的电链锯包含以下功能，有助于降低回弹风险；不过，这些功能不会完全消除该危险的反应。作为链锯用户，请勿仅仅依赖于安全设施。您必须遵循本手册中所有的安全防范措施、说明和维护措施，帮助避免可能造成严重受伤的回弹和其他作用力。

- 防反弹导板带有一个小型半径尖端，能够缩小导板尖端的回弹危险区域面积。在根据电动链锯的安全要求进行测试时，证明防反弹导板能够显著减少回弹的次数和严重程度。
- 低回弹链锯带有等高线深度计以及导板连接，能够转移回弹力度，同时让切刀逐渐切入。
- 请勿在树上、梯子上、脚手架上或任何不稳定的支撑上操作链锯。
- 当在紧固件可能会触碰到暗线的场所进行操作时只能通过绝缘握持面来握住工具。紧固件碰到带电导线会使工具外露的金属零件带电而使操作人员受到电击。
- 请勿尝试一些超出自身能力或经验的操作。请仔细阅读本说明手册的所有说明并理解其中的内容。
- 在开启链锯前，请确保链锯没有接触任何物体。
- 请勿单手操作链锯！这样可能会对操作人员、帮手或旁观者造成严重伤害。只能用双手操作链锯。
- 保持手柄干燥、清洁，不得沾有油脂。
- 请勿让灰尘、碎屑或锯末在电机或外侧排气口上累积。
- 先关停链锯，再将其放下。
- 请勿切割藤蔓和/或小树枝。

- 在切割小刷子和枝条时，请极度小心，因为纤细的材料可能会缠绕锯链配件或让您失去平衡。



警告：由动力砂光、锯切、研磨、钻孔和其他施工活动产生的粉尘会包含一些化学成分。加州政府认为这些化学成分会引发癌症、生育缺陷或其他生殖伤害。部分化学成分如下：

- 含铅涂料中的铅
- 砖块、水泥和其他砖产品中的结晶二氧化硅，以及
- 经化学处理的木材中的砷和铬

您暴露在粉尘中的风险大小取决于您开展此类工作的频率。为减少您对这些化学成分的暴露：请在通风良好的环境中工作，请穿戴经过批准的安全设备，例如转为过滤微小颗粒的防尘面具。

- 避免与动力砂光、锯切、研磨、钻孔和其他施工活动产生的粉尘长时间接触。请穿好防护服并用肥皂和水清洗身上暴露在外的区域。如果粉尘进入嘴巴、眼睛或落在皮肤上，可能会让身体吸收更多有害的化学成分。



警告：使用这款工具会产生和/或生成粉尘，从而造成严重且持久的呼吸损伤或其他损伤。

链锯的名称和使用期限

- 造材——交叉切割倒下的树木或原木，将其切成若干段。
- 电机制动——在松开触发开关后，让锯链停止转动的设备。
- 链锯动力头——不含锯链和导板的链锯。
- 驱动链轮或链轮——驱动锯链转动且带有齿轮的部件。
- 伐木——锯倒一棵树的过程。
- 树倒背面切割——伐木时的最后一次切割，即在开槽切口的对面进行切割。
- 前方手柄——位于或朝向链锯前方的支持手柄。
- 前方护手——在前方手柄和导板之间的结构屏障，一般紧靠前方手柄的手的位置。
- 导板——一个结实的轨道结构，能够支撑和引导链锯。
- 导板鞘——安装在导板上的外壳，防止在不使用链锯时触碰到锯齿。
- 回弹——当锯链靠近导板顶部区域的尖端，触碰到任何物体（例如原木、枝条）时，或木材在切割时靠近并卡住锯链时，导板向后或向上，或向后上方移动的动作。
- 回弹，卡住——在切割时，木材接近并卡住转动的锯链，导致电链锯迅速回弹。
- 回弹，转动——在导板尖端的上半部分移动锯链并触碰到物体，例如原木或枝条，导致电链锯快速向上和向后的移动。
- 打枝——切除倒下的树木上的枝条。
- 低回弹锯链——能降低回弹表现要求的锯链。（在锯链代表样本上进行测试时）。
- 常规切割位置——在进行造材和伐木切割时假定的位置。
- 开槽下锯口——在树木倒下的方向进行的开槽切割。
- 后方手柄——位于或朝向链锯后方的支持手柄。
- 降防反弹导板——能够显著减少回弹的导板。
- 替代锯链——在用特定的电链锯进行测试时，能够降低回弹要求的锯链。
- 链锯——带有锯齿的链环，能够切割木材，由电机驱动并由导板提供支持。
- 肋条凸起——在伐木或造材时使用，作为在切割时旋转电链锯的支点并保持位置。
- 开关——接通或中断链锯电机电路的装置。

- 开关连杆——将动作从触发器传递到开关的机制。
- 开关锁定——一种可移动的止动块，能防止开关被意外打开，使其只能被手动激活。

剩余风险

尽管遵守了相关安全法规并采用安全装备，但某些剩余风险依然不可避免。它们是：

- 听力损伤。
- 由于飞溅颗粒而导致的人身伤害。
- 由于配件在操作时发烫而产生的灼烧风险。
- 由于长时间使用而导致的人身伤害。

电气安全

电机只适用一种工作电压。请务必检查电池包的电压是否是铭牌上的电压一致。另外，请确保充电器电压和主电源的电压一致。



DeWALT 充电器符合 IEC60335 双重绝缘要求，因此无需使用接地线。

如果电源线损坏，必须由 DeWALT 服务机构用专用线缆进行更换。





请妥善保管好这些说明

充电器

DeWALT 充电器无需做出任何调整，专为简易操作而设计。



针对所有电池充电器的重要安全说明

请妥善保管好这些说明：本手册包含重要的相容电池充电器安全和操作说明（请参见**技术参数**）。

- 在使用充电器之前，请先阅读所有指示以及充电器、电池包和使用电池包的产品上的警告标记。
-  **警告：**触电危险。切勿让任何液体进入充电器，否则可能会导致触电。
-  **警告：**我们建议使用漏电保护额定电流为 30 毫安培或以下的漏电保护装置。
-  **警告：**灼伤危险。为降低人身伤害风险，请使用 DeWALT 充电式电池充电。使用其他类型的电池可能会引起爆裂，并导致人身伤害和损害。
-  **警告：**应看管好儿童，以确保他们不将此设备当做玩具来玩。
注意：在某些情况下，当充电器的插头插入电源插座时，充电器内部裸露的充电接触点可能因为外来物件而短路。请勿让可导电的异物靠近充电器腔，这些外来物件包括但不限于钢棉、铝箔或任何金属颗粒的堆积物。充电器内没有电池包时，请断开充电器与电源的连接。清洗前，务必拔掉充电器。
- 请勿试图使用本手册指定的充电器以外的其他任何充电器为电池包充电。**充电器和电池包都是专门设计的，互相配合使用。
- 除了为 DeWALT 充电式电池充电以外，这些充电器并非设计用于其他用途。**否则，可能会导致火灾、触电或电击。
- 请勿将充电器暴露于雨中或雪中。**
- 断开充电器连接时，应拔下插头，切勿拉拽电源线。**这将降低对电插头和电线的损害风险。
- 确保电源线布置在不易踩踏、踢绊、拉扯或会受到损害或压力的位置。**
- 除非绝对必要，否则请勿使用延长线。**使用不正确的延长线可能导致火灾、触电或电击的风险。

- **请勿将任何物件放在充电器上面，或是把充电器放在可能会堵住通风槽的柔软表面，导致充电器的内部过热。**请把充电器放置在远离任何热源的地方。充电器通过外壳顶端和底端的槽进行通风。
- **禁止使用电源线或插头已损坏的充电器，请立即更换这些充电器。**
- **如果充电器受到强烈重击、掉落或出现其他损坏情况，请勿使用充电器。**请将损坏的充电器送到授权服务中心。
- **请勿自行拆卸充电器。请将需要检修或修理的充电器送到授权服务中心。**重装不正确可能导致触电、电击或火灾风险。
- 必须立即将已损坏的电源线交由制造商、服务代理或类似的合格人员进行更换以防止安全隐患。
- **清洁前，请先断开充电器和插座的连接，以降低触电风险。**取出电池包不会降低此风险。
- **不得将两个充电器连接在一起。**
- **充电器是为 220-240V 的标准家用电源而设计。请勿试图在任何其他电压下使用充电器。**此规则不适用于车载充电器。

为电池充电 (图 B)

1. 插入电池包前，先将充电器的插头插到相应的电源插座上。
2. 将电池包  插入到充电器中，确定电池包安装到位。红色 (充电中) 指示灯将不断闪烁，表示充电过程已经开始。
3. 红色灯持续亮起表示充电完成。此时电池包已完全充电，您可以使用电池包或将电池包留在充电器上。如需从充电器上取下电池包，请按下电池包上的电池释放按钮 。

注意：为了确保锂离子电池的效能和使用寿命最大化，在首次使用电池包之前必须将其完全充电。

充电器操作

关于电池包的充电状态，请参见以下指示灯说明。

充电状态指示灯



*红色指示灯会继续闪烁，但黄色指示灯在本次操作过程中会亮起。电池包达到适当温度后，黄色指示灯会熄灭，充电器将恢复充电程序。

兼容的充电器不会对故障电池包充电。充电器拒绝亮起或显示问题电池包或进入闪烁模式，标记出现故障的电池。

注意：这也可能意味着充电器有故障。

如果充电器提示存在故障，请将充电器和电池包送到授权的服务中心进行测试。

高温/低温电池包延迟

当充电器检测到电池包过热或过冷时，它会启动加热/冷电池延迟模式，暂停充电，直到电池包达到适当的温度。然后，充电器会自动切换到电池包充电模式。此功能可确保电池包拥有最长的使用寿命。

冷电池包充电速度比热电池包充电速度慢。电池包在整个充电周期的充电速度都会较慢，即使电池包升温也不会恢复到最大速度。

DCB118 充电器配备专用于冷却电池包的内部风扇。电池包需要冷却时，风扇会自动启动。如果风扇运转不正常或通风槽堵塞，切勿操作充电器。请勿让异物进入充电器内部。

电子保护系统


XR 锂离子电池工具具有电子保护系统设计，可保护电池包免受超载、过热或过度放电之害。

如果电子保护系统处于运作状态，该工具将自动停止操作。如果发生这种情况，请将锂离子电池包放在充电器上，直至其完全充电。

壁挂式安装

这些充电器设计为可以安装在墙上，也可以直立在桌面或工作台上。如果安装在墙上，请确保充电器的位置可以连接到电源插座，并且远离墙角或其他可能妨碍空气流通的障碍物。将充电器背面作为在墙上安装螺钉的位置模板。使用至少 25.4 毫米长、螺钉帽直径至少 7-9 毫米的石膏板螺钉 (单独购买) 牢牢固定充电器，将螺钉最大限度打入木材，预留约 5.5 毫米露在墙外。将充电器背面的安装槽对准露出的螺钉，完全放置到位。

充电器清洁说明

 **警告：触电危险。**清洁前，请将充电器从交流电源插座上拔下。可用布或非金属软刷清除充电器外部的污垢和油脂。请勿使用水或任何清洁剂。切勿让任何液体渗入工具，切勿让工具的任何部件浸在液体中。

电池包


针对所有电池包的重要安全说明


在订购更换电池包时，请务必附上目录型号和电压。

包装箱内的电池包并未完全充电。使用电池包和充电器之前，请阅读下列安全说明，然后遵循所述的充电程序。

请阅读所有说明

- **请勿在易爆环境，如有易燃液体、气体或粉尘的环境中充电或使用电池。**在充电器中插入或取出电池时可能会点燃粉尘或气体。
- **切勿强行将电池放进充电器。请勿以任何方式改装电池包并将电池包插入不兼容的充电器，这种操作可能会导致电池包破裂，造成严重的人身伤害。**
- 仅使用 DeWALT 充电器为电池包充电。
- **请勿喷漆电池包或将其浸泡在水或其他液体中。**
- **请勿在温度可能达到或超过 40 °C (104 °F) 的地方 (如夏天户外的棚子或金属建筑物中) 存放或使用工具和电池包。**
- **即使电池包严重受损或完全损坏，也请勿焚化电池包。**电池包在火中会发生爆炸。锂离子电池包在燃烧时会释放有毒气体和物质。
- **如果电池液体接触到皮肤，请立即以中性肥皂和清水冲洗接触的地方。**如果电池液体不慎进入眼睛，应睁开眼睛并用清水冲洗至少 15 分钟或直到刺激感消失。如果需要医疗救助，请告知医护人员。电池电解质由液状有机酸盐和锂盐的混合物组成。
- **已打开电池的內部物质可能导致呼吸道刺激。**请保持空气流通。如果症状持续存在，请就医。

 **警告：灼伤危险。**电池液如果接触到火花或火焰可能会燃烧。

 **警告：**勿以任何理由试图打开电池包。电池包外壳破裂或损坏时，请勿将电池包插入充电器。请勿挤压、掉落或损坏电池包。请勿使用受过强烈重击、掉落、碾压或以任何其他方

式(如被钉子穿破、受到锤子的重击、踩踏)受损的电池包或充电器,否则可能会引起触电或电击。损坏的电池包应送回服务中心进行回收。



警告:火灾危险。请勿在存储或搬运电池包时让金属物品接触暴露的电池两极。例如,请勿将电池包放在围裙、口袋、工具箱、产品套件盒、抽屉等可能与散钉、螺钉、钥匙等物品接触的地方。



警示:不用时,将工具侧放在平稳的表面上,确保不会有踢绊或掉落危险。一些具有大型电池包的工具将直立于电池包之上,但可能会轻易被撞倒。

运输



警告:火灾危险。电池运输途中,如果电池两极意外接触导电材料,可能会引发火灾。运输电池时,务必保护电池两极,确保与可能接触电池导致短路的材料良好绝缘。

DeWALT 电池符合所有适用的行业和法律标准规定的运输规范,包括《联合国危险品运输建议规章模板》(UN Recommendations on the Transport of Dangerous Goods)、《国际航空运输协会 (IATA) 危险品规则》(International Air Transport Association (IATA) Dangerous Goods Regulations)、《国际海运危险品 (IMDG) 规则》(International Maritime Dangerous Goods (IMDG) Regulations) 和《欧洲危险货物国际公路运输协定》(European Agreement Concerning The International Carriage of Dangerous Goods by Road) (ADR)。锂离子电池和电池包已遵循《联合国危险品运输建议规章范本手册》第 38.3 节关于测试和标准的说明通过测试。

大多数情况下,发运 DeWALT 电池包不属于完全管制的 9 类危险品。通常情况下,只有当运输包含一个能量等级大于 100 瓦时 (Wh) 的锂离子电池时,才需要作为完全管制的 9 类危险品发运。所有锂离子电池外壳上均标注有瓦时等级。此外,由于法规比较复杂,无论瓦时等级是多少,DeWALT 都不建议单独空运锂离子电池。发运包含电池的工作(组合套件)时,如果电池包的能量等级不大于 100 瓦时 (Wh),则可以按计划空运。

无论发运是否纳入完全管制范围内,运输公司均有责任遵循最新法规中关于包装、标签/标记和单据的要求。

本手册本节的信息是出于善意提供,且认为在编制文档时准确无误。不提供直接或间接的担保。购买方负有确保其行为遵守适用法规的责任。

运输 FLEXVOLT™ 电池

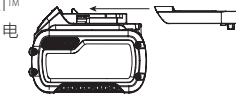
DeWALT 的 FLEXVOLT™ 电池有两种模式:**使用和运输。**

使用模式:当 FLEXVOLT™ 电池单独使用或用于 DeWALT 18 伏(最大 20 伏)产品时,将作为功率为 18 伏(最大 20 伏)的电池进行操作。当 FLEXVOLT™ 电池用于 54 伏(最大 60 伏)或 108 伏(最大 120 伏)两个 54 伏(最大 60 伏)电池的产品时,将作为 54 伏(最大 60 伏)的电池进行操作。

运输模式:当电池盖连接到 FLEXVOLT™ 电池时,电池会进入运输模式。保留电池盖用于运输。

处于运输模式时,电池包内部的电池芯会处于断电状态,使 3 个低瓦时 (Wh) 等级的电池相当于 1 个高瓦时等级电池。这样,增加 3 个低瓦时等级的电池可以使电池包不必遵守适用于更高瓦时电池的运输法规。

例如,若运输额定瓦时为 3 x 36 瓦时,则表示 3 个 36 瓦时的电池。使用瓦时额定值可能是 108 瓦时(表示 1 个电池)。



使用和运送标签标记示例



存放建议

1. 最好将电池存放在阴凉、干燥、远离阳光直射、不会过热或过冷的地方。为获得最佳的电池性能和使用寿命,请您在不使用电池包时将其存储在室温下。
2. 长期存储时,建议将完全充电的电池包从充电器取出,存储在阴凉、干燥的地方,以达到最佳效果。

注意:电池包不应在电池已完全耗尽的状态下存放。使用电池包之前,必须重新为电池包充电。

充电器和电池包上的标签

除了在本手册中所使用的标志,充电器和电池包的标签还包括:



使用前请阅读使用手册。



有关充电时间的详细信息,请参见**技术参数**。



请勿使用导电物体截刺。



请勿对损坏的电池包充电。



请勿将其暴露于水中。



应立即更换有缺陷的电线。



请只在 4°C 和 40°C 之间的温度下充电。



只能在室内使用。



丢弃电池包时,请妥善处理以保护我们的环境。

LI-ION



仅使用指定的 DeWALT 充电器为 DeWALT 电池包充电。使用 DeWALT 充电器为非 DeWALT 电池充电可能会导致电池爆炸或出现其他危险情况。



请勿焚化电池包。



使用(无电池盖)。示例:瓦时额定值为 108 瓦时(1 个 108 瓦时的电池)。



运输(有内置运输盖)。示例:瓦时额定值为 3 x 36 瓦时(3 个 36 瓦时的电池)。

电池类型

DCM575 需要 54 伏(最大 60 伏)的电池包才可运行。

这些电池包可用于: DCB546, DCB547, DCB548, DCB606, DCB609, DCB612。更多信息,请参见**技术参数**。

包装内的物品

包装内的物品包括:

- 1 链锯
- 1 鞘

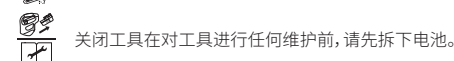
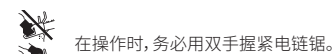
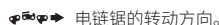
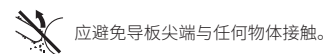
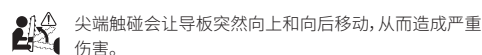
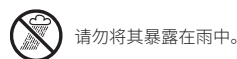
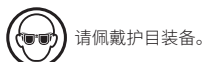
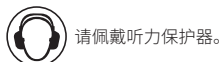
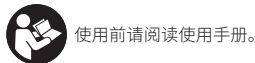
- 1 导板 40 厘米
- 1 锯链 40 厘米
- 1 本说明手册

不包含电池或充电器

- 1 锂离子电池包**
- 1 锂离子电池充电器**
- **仅 DCM575X1 随附
- 检查工具、部件或附件是否在运输过程中损坏。
- 操作前，请抽空仔细阅读并掌握本手册。

工具上的标记

工具上印有下列图形：



日期代码位置

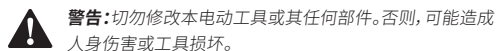
包含制造年份的日期码打印在工具外壳上。

示例：

2021 XX XX

制造年份

说明 (图 A)



- 1 变速触发开关 (图 C)
- 2 锁定杆
- 3 锯链制动/前方护手
- 4 导板
- 5 锯链
- 6 链轮盖
- 7 电池包
- 8 导板调节锁定把手
- 9 锯链张紧把手

- 10 油位指示器
- 11 导板鞘
- 12 后方手柄
- 13 前方手柄
- 14 电池外壳
- 15 电池释放按钮
- 16 油帽 (未显示)

设计用途

您的 DeWALT DCM575 链锯非常适合修剪和切割最大直径达 35 厘米的原木。

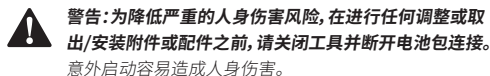
您的链锯适用于专业切割用途。

请勿在潮湿环境中，或在存在易燃液体或气体的环境中使用本工具。链锯是专业电动工具。

请勿让儿童接触本工具。缺乏经验的操作员需要在监督下使用本工具。

- **儿童和体弱者。**在没有他人监督的情况下，儿童或体弱者不适宜使用本产品。
- 本产品不适合体力、感官或智力不足以及缺乏经验、知识或技能的人员 (包括儿童) 使用，除非一旁有能为他们的安全负责的监督人员。不得在无人监管的情况下让儿童接触本产品。

组装与调整



将电池包插入工具/从工具上拆除电池包 (图 C-E)

注意：确保电池包 7 充满电。

要将电池包安装到工具手柄中

1. 将电池包 7 与工具内的轨道 (图 C)。
2. 将电池包滑入手柄内，使其牢牢地固定在工具内，并确保您听到其锁定到位的声音。

从工具中拆除电池包

1. 按下释放按钮 15，将电池包从工具手柄中稳妥地拉出 (图 D)。
2. 按本手册充电器部分所述将电池包插入充电器中。

电池包电量计 (图 E)

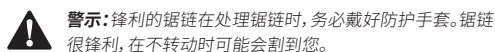
一些 DeWALT 电池包带有一个包含三个绿色 LED 指示灯的电量计，用于指示电池包内的剩余电量。

按下电量计按钮 17 不松开，即可启动电量计。三个绿色 LED 指示灯将以组合方式亮起，以指示剩余电量。当电池内的电量低于可用限制时，电量计将不会亮起，电池将需要重新充电。

注意：电量计仅指示电池包的剩余电量。它并不表示该工具的功能，且将根据产品组件、温度和最终用户的使用情况而有所不同。

组装

安装导板和锯链 (图 A, F-H, K)



警告：转动的锋利锯链为防止意外启动，请确保先从工具上拆下电池，再进行以下操作。如果未能这样做，可能会造成严重的人身伤害。

锯链 5 和导板 4 都用纸盒分别包装。锯链必须装到导板上，而且二者都必须安装到工具的主体上。

- 将链锯置于平坦、坚实的表面上。
- 翻转锁定杆，逆时针转动导板调节锁定把手 8，如图 F 所示，拆除链轮盖 6。
- 戴好防护手套，握住锯链 5 并将其绕在导板 4 上，确保锯齿朝向正确（参见图 K）
- 确保锯链在沟槽摆放妥当，要环绕整个导板。
- 将锯链围绕链轮 18 摆放。将导板上的槽与链条张紧销 20 和螺钉 19 对齐，并将其置于工具底座上，如图 G 所示。
- 在到位后，让导板保持静止，更换链轮盖 6。确保盖子上的无工具张紧集成螺孔与主外壳上的螺母 19 对齐。翻转锁定杆并顺时针转动导板调节锁定把手 8 直到卡紧为止，然后将把手松开一圈，让锯链能够适当张紧。
- 顺时针转动锯链张紧把手 9，增加张力，如图 H 所示。确保锯链 5 围绕导板 4 卡紧。拧紧导板调节锁定把手 8 直到卡紧为止。

调节锯链张紧度 (图 A, I)

警告：锋利的锯链在处理锯链时，务必戴好防护手套。锯链很锋利，在不转动时可能会割到您。

警告：转动的锋利锯链为防止意外启动，请确保先从工具上拆下电池，再进行以下操作。如果未能这样做，可能会造成严重的人身伤害。

- 将链锯置于平整、坚实的表面上，检查锯链 5 的张紧度。如果用食指和拇指轻轻拉动锯链，使其距离导板 4 3 毫米远，如图 I 所示，然后松开，锯链能够迅速弹回，则张紧度是适宜的。如图 I 所示，底面上的导板和链条之间不应存在“下垂”情况。
- 如需调节锯链的张紧度，翻转锁定片，逆时针转动调节锁定把手 8 一圈。顺时针转动锯链张紧把手 9，直到张紧度达到上述要求。
- 请勿让锯链过度张紧，这会导致过度磨损，缩短导板和锯链的使用寿命。
- 一旦达到正确的张紧度，请拧紧导板调节锁定把手。
- 如果是新的锯链，请在使用的前 2 小时中，经常检查张紧度（先要拆下电池），因为新锯链会稍稍拉伸。

更换锯链 (图 A, K)

警告：锋利的锯链在处理锯链时，务必戴好防护手套。锯链很锋利，在不转动时可能会割到您。

警告：转动的锋利锯链为防止意外启动，请确保先从工具上拆下电池，再进行以下操作。如果未能这样做，可能会造成严重的人身伤害。

- 翻转锁定片，逆时针转动调节锁定把手 8，让锯链松弛。
- 按照**安装导板和锯链**部分中的说明，拆除链轮盖 6。
- 将磨损的锯链 5 从导板 4 凹槽中拉起。
- 将新锯链放入导板槽中，将锯链上的箭头与链轮盖 6 上的图标对齐，确保锯齿朝向正确，如图 K 所示。
- 请按照**安装导板和锯链**中的说明进行操作。

您可从距离您最近的 DeWALT 服务中心获得更换锯链和导板。

- DCMS75 要求使用 # DWRC1600 更换锯链，零部件编号 N594321。更换 40 厘米的导板，零部件编号 N594320。

锯链和导板上油处理 (图 L)

自动上油系统

这款链锯配有自动上油系统，能够保持锯链和导板始终得到润滑。油位指示器 10 会显示链锯中油位。如果油位不足四分之一，请先拆除电池，再注入正确类型的油。在完成切割后，务必清空油箱。

注意：请使用高品质导板和锯链油，为锯链和导板进行适当的润滑。作为临时替代品，可使用非清洁剂 SAE30 重量电机油。修剪树木时，建议使用基于植物的导板和锯链油。不建议使用矿物油，因为这可能损坏树木。不得使用废弃油或很粘稠的油。这可能会损坏您的链锯。

装填储油仓

- 向下翻转锁定杆，逆时针将螺钉转动四分之一圈，然后拆除油盖 16。注入推荐的导板和锯链油，直到油位达到油位计 10 的顶部为止。
- 盖好油盖并顺时针拧紧四分之一圈。将锁定杆向上翻动到锁定的位置。
- 定期关闭链锯，检查油位计，确保导板和锯链都得到适当的润滑。

运输链锯 (图 A, M)

- 在运输工具时，务必先从工具上拆除电池，并用鞘 11 盖住导板 4 (图 M)。
- 向前推动锯链制动/前方护手 3，让锯链制动接合。

操作

使用说明

警告：请始终遵守安全法规以及适用规章的要求。

警告：为降低严重的人身伤害风险，在进行任何调整或取出/安装附件或配件之前，请关闭工具并断开电池包连接。意外启动容易造成人身伤害。

正确的双手放置位置 (图 A, J)

警告：为了减低严重人身伤害的风险，请务必如图示那样正确放置双手。

警告：为了降低严重人身伤害的风险，预期有突然反作用力时**务必**握紧。

将双手放在适当位置，将左手置于前方手柄 13，将右手置于后方手柄 12。

操作链锯 (图 A, N-0)

警告：阅读并理解所有的说明。不了解以下所列所有说明将导致电击、火灾和/或严重伤害。

- 预防回弹。这可能会造成严重伤害，甚至死亡。参见重要安全说明**预防回弹**部分，避免回弹风险。
- 请勿让手过分伸展。请勿在高于胸口的位置进行切割。请确保站稳。双脚要分开。将自身重量均匀分布在两脚之上。
- 左手握紧前方手柄 13，右手握紧后方手柄 12，让身体位于导板左侧。
- 请勿通过前方护手/锯链制动 3 握住链锯。让左手肘部固定住，让左手保持笔直，抵御回弹。

警告：不得交叉握把 (左手握后方手柄，右手握前方手柄)。

警告：在操作链锯时，不得让自己身体的任何部位与导板 4 成一条直线。

- 当您在树上，处于任何不恰当的位置或梯子上，或不稳定的表面上时，不得操作该工具。您可能会失去对电链锯的控制，从而导致严重伤害。
- 当您在切割时，请让链锯始终全速运转。
- 让链锯为您切割。仅向工具施加少许压力。请勿在结束切割时，向链锯施加压力。

警告：当不使用链锯时，务必接合链锯制动并拆除电池。

开关

务必确保正确站姿，同时双手握紧链锯，让大拇指和其他手指都握住两个手柄。

该工具配有变速触发开关。如需关闭工具，请确保没有接合锯链制动。如图N所示，推下锁定杆 ② 并扣动触发开关 ①。当工具开始运转，您就可以松开锁定杆。越是用力扣动触发开关，工具转速就越快。

为让工具保持运转，必须继续扣动触发开关。如需关闭工具，请松开扳机开关。

注意：如果切割时用力过猛，链锯会关闭。如需重启，必须松开锁定杆 ② 和触发开关 ①，再重启链锯。再次开始切割，要减少用力。让链锯按照自己的节奏切割。

警告：不得试图将开关锁定在“开”的位置。

设置锯链制动

您的链锯配有电机链锯制动系统，如果出现回弹，该系统会迅速停止锯链。

- 从工具中取出电池包。
- 如需接合链锯制动，请向前推动链锯制动/前方护手 ③，直到它到位为止。
- 朝着前方手柄 ⑬ 的方向，将链锯制动/前方护手 ③ 拉动到“设定”位置，如图O所示。
- 现在，就可以使用工具了。

注意：如果出现回弹，您的左右就会触碰到前方护手。请朝着工件的方向，向前推动护手。这会让工具停止。

测试锯链制动

每次使用前，请测试锯链制动，确保链锯能够正确运转。

- 将工具置于平坦、坚实的表面。请确保锯链 ⑤ 离开地面。
- 双手紧握工具并打开链锯。
- 围绕前方手柄 ⑬ 向前转动左手，让手背触碰到锯链制动/前方护手 ③，同时朝着工件的方向向前推动。锯链应立即停止。

注意：如果链锯未能立即停止，请停止使用工具并将其送至距离您最近的 DEWALT 服务中心。

警告：在切割前，请确保先设定锯链制动。

常用切割技术 (图 A, P, Q, U, V, W)

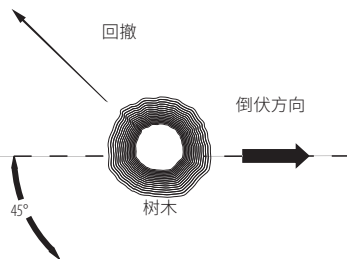
伐木

锯倒一棵树的过程。请先确保电链锯充满电，然后再切割树木，让您能够充电一次就能完成切割。请勿在大风天进行该操作。

警告：木材可能会导致受伤。只能由训练有素的人员进行该操作。

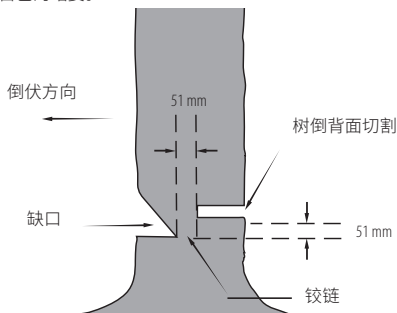
- 如有必要，应先规划并开辟一条回撤路线，再进行切割。回撤路线应向后延伸，并与预期的树木倒伏的方向呈对角线。(图U)

图U



- 在开始伐木前，请考虑树木的自然倾斜度，粗大树枝的位置以及风向，综合判断树木的倒伏方向。请在手边准备好楔子(木头、塑料或铝)和重木槌。在有待进行造材的区域，请事先清除灰尘、石头、掉落的树皮、钉子、U形钉和树上的电线。
- 开槽下锯口——开出一个占树干直径 1/3 的缺口，使其与倒伏方向垂直。先进行下方的水平缺口切割。在切割第二个缺口时，这有助于避免锯链或导板被挤压(图V)
- 上锯口——切割上锯口时，要使其比水平缺口高出至少 51 毫米。切割上锯口时，要使其与水平缺口切割保持水平。切割上锯口，从而留下足够木材，使其起到铰链的作用。用作铰链的木材能让树木免于扭转并倒向错误的方向。请勿切断铰链(图V)
- 当伐木切割接近铰链时，树木应该开始倒伏。如果树木未能倒向理想的方向，或向后倒伏并缠住锯链，请在完成伐木前停止切割，同时使用楔子打开切口，让树木沿着理想的倒伏线倒下。当树木开始倒伏，请从切口上拿下链锯，停止电机，放下链锯，然后按照计划好的回撤路线退回。请警惕掉落下来的过热枝条，同时注意自己的站姿。

图V



打枝

切除倒下的树木上的枝条。在打枝时，请保留处于低位的较大枝条，以便支撑树干，使其不碰到地面。一次性减除小枝条。对于处于紧绷状态的树枝，应沿着自下而上的方向切割，避免如图P所示，让链锯被缠住。从对面修剪枝条，让树干始终位于您和链锯之间。切割时，不得让链锯位于两腿之间，骑坐在待切割的枝条上。

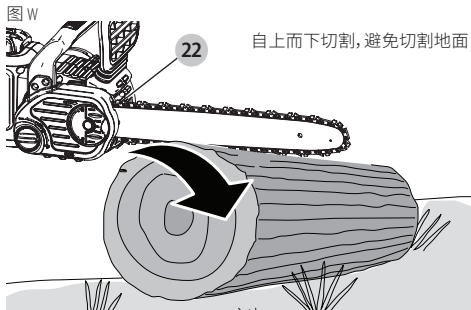
造材

警告：建议首次使用的用户先应在锯马上练习几次。

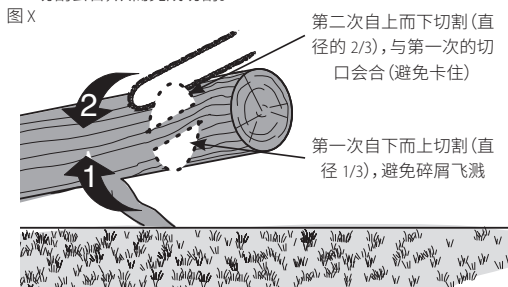
将已经倒下的树木或原木切割成若干段。您的切割方式取决于原木的支撑方式。如果可能，请使用锯马(图Q)。

- 务必等到锯链全速转动，才能开始切割。
- 请将链锯的底针 ②② 放在初次切割区域的背后，如图W所示。
- 打开链锯，向下转动锯链和导板，切入树木中，同时将底针作为铰链。

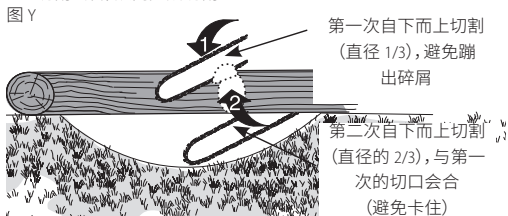
- 当链锯达到 45° 角时，再次放平链锯并重复这些步骤，直到完全切开为止。
- 当树在整个长度上都受支撑，请从顶部开始切割，但要避免切到地面，因为这会使链锯迅速钝化。



- **图 X** - 如果一端有支撑
首先，从下方切割直径的 1/3。然后，再从顶部切割，与第一次的切割会合，从而完成切割。



- **图 Y** - 如果两端都有支撑
首先，从上向下切割 1/3。然后，再从下往上切割 2/3，与第一次的切割会合，从而完成切割。



- 当处于斜坡上时，务必站在原木的上坡侧。当“切开”时，请保持完全控制，始终握紧链锯手柄，以降低切割完成时的切割压力。请勿让链锯接触地面。完成切割后，先等待链锯完全停止，再移动链锯。务必先停止电机，再从切口移动到另一个切口。

保养和维护

仅使用温和的肥皂和湿布来清洁工具。请勿使用溶剂来清洁链锯的塑料外壳。切勿让任何液体渗入工具，切勿让工具的任何部件浸在液体中。

重要：为确保产品安全、可靠，维修、养护和调整都应由获得 DeWALT 授权的服务中心完成，务必使用相同的零部件来替换。

定期养护可延长链锯的使用寿命。

锯链和导板

每使用几个小时，请拆除链轮盖、导板和锯链并用软毛刷彻底清洁。请确保导板上的油孔中没有碎屑。在用锋利的锯链替换钝化的锯链时，正确的做法是自下而上翻开链锯导板。

锯链磨锐 (图 R-T)

- 警告：**锋利的锯链在处理锯链时，务必戴好防护手套。锯链很锋利，在不转动时可能会割到您。
- 警告：**转动的锋利锯链为防止意外启动，请确保先从工具上拆下电池，再进行以下操作。如果未能这样做，可能会造成严重的人身伤害。

注意：如果切刀在切割时碰到地面或钉子，就会立即钝化。

如需让链锯发挥最佳性能，那么则应保持锯链锋利。请遵循这些建议，对锯链进行适当地磨锐：

1. 如需获得最佳效果，请使用 4.5 毫米的锉刀和锉刀支架，或锉刀导轨来磨锐锯链。这能确保您始终都能维持恰当的磨锐角度。
2. 将锉刀支架平放在切刀的顶板上和深度计上。
3. **图 R** - 在锉刀导轨上与锯链 (从侧面看，锉刀与锯链成 60° 角) 保持 30° 顶板 (21) 锉刀角度线。
4. 先对锯链一侧的切刀进行磨锐。对每个切刀从内到外地进行打磨。然后，将链锯翻转过来并在锯链另一侧的切刀上重复该流程 (2, 3, 4)。
注意：请使用平整的锉刀来打磨 raker 的顶部 (切刀前面的链环部分)，使其位于切刀尖端下方约 0.635 毫米的位置，如图 S 所示。
5. **图 T** - 让所有切刀的长度保持相等。
6. 如果顶板或侧板的铬表面上有损坏，请用锉刀打磨，直到损坏被清除。

- 警告：**在用锉刀打磨后，切刀会变得锋利，在此过程中请多加小心。

注意：每次磨锐锯链时，锯链就会丧失部分低回弹的属性，因此请务必小心。建议磨锐锯链的次数不要超过四次。

配件

- 警告：**使用本手册中未推荐的配件可能会造成危害。

您可从距离您最近的 DeWALT 授权服务中心获得更换锯链和导板。仅可使用低回弹导板和锯链。

可用于 DCM575 的导板和锯链：

- 导板： 40 厘米服务部件编号 N594320
46 厘米服务部件编号 N594315
- 锯链： 40 厘米服务部件编号 N594321
46 厘米服务部件编号 N594318

维护

您的 DeWALT 电动工具设计精良，可以长期使用，仅需极少维护。若要持续令人满意的工作效果，则需对工具进行适当的保养和定期清洁。

- 警告：**为降低严重的人身伤害风险，在进行任何调整或取出/安装附件或配件之前，请关闭工具并断开电池包连接。意外启动容易造成人身伤害。

充电器和电池包无法维修。



润滑剂

请参见 **锯链和导板上油处理 (图 L)**



清洁



警告：一旦看到通风口及其周围积聚了尘屑，请用干燥的空气将灰尘和尘屑从主机外壳内吹出。进行此步骤时，请佩戴经认可的护目装备和面罩。



警告：切勿使用溶剂或其它刺激性化学制品来清洁工具的非金属部件。这些化学品可能削弱此类部件中使用的材料。只可使用蘸有软性肥皂水的抹布进行清洁。切勿让任何液体渗入工具，切勿让工具的任何部件浸在液体中。

可选配件



警告：除了 DeWALT 提供的附件之外，其他附件都未经此产品兼容性测试，若将此类附件与本工具一起使用将存在安全隐患。为降低人身伤害风险，本产品只可使用 DeWALT 推荐的附件。

请向您的经销商咨询更多关于合适附件的信息。

保护环境



分类回收。本产品不得与普通家庭垃圾一起处理。

再循环材料的重新利用有助于防止环境污染和减少原料需求。请根据当地供给回收电子产品和电池。如需获得更多信息，请访问 www.2helpU.com。

充电式电池包

本电池包使用寿命长，如无法提供顺利完成工作所需的电力时，必须进行充电。电池技术寿命结束时，请妥善处理以保护环境：

- 耗尽电池包的电力，然后将其从工具上拆下。
- 锂离子电池是可回收的。请将它们送往您的经销商处或当地的回收站。回收的电池包将被妥善循环使用或处理。

售后服务和维修

DeWALT 维修中心拥有经过培训的人员，能够为顾客提供充分、可靠的产品服务。如果您通过未获授权的维修中心进行维修，我们不会承担任何责任。您可以参见产品包装中的“联系中心定位器”宣传单页，通过热线电话、网站或社交媒体联系我们，找到距离您最近的 DeWALT 服务中心。

故障解决

问题	解决方案
工具无法启动	<ul style="list-style-type: none"> • 检查电池安装情况。 • 查看电池的充电要求。 • 在移动主触发开关前，先检查是否完全推下锁止。
工具在使用时关闭	<ul style="list-style-type: none"> • 为电池充电。 • 工具被强行使用。重启并减轻施加的压力。

问题	解决方案
无法为电池充电	<ul style="list-style-type: none"> • 将电池插入充电器，直到红色指示灯亮起。如果电池电量耗尽，请充电 8 小时。 • 将充电器插入可正常使用的插座中。参见 重要充电说明，了解更多详情。 • 插上一台电器，检查插座上的电流情况。 • 检查插头是否连接到照明开关，导致关闭照明时，也关闭了工具的电源。 • 将充电器和电器移动到室温高于 4.5 °C 或低于 40.5 °C 的环境中。
导板/锯链过热	<ul style="list-style-type: none"> • 参见 调节锯链张紧度 部分。 • 参见 锯链上油 部分。
锯链松弛	<ul style="list-style-type: none"> • 参见 调节锯链张紧度 部分。
切割质量差	<ul style="list-style-type: none"> • 参见 调节锯链张紧度 部分。注意：过度张紧会导致过度磨损，缩短导板和锯链的使用寿命。先润滑，再切割。参见 更换锯链 部分。
工具运转但不切割	<ul style="list-style-type: none"> • 锯链的安装方向可能反了。参见安装和拆除锯链的部分。
无法为工具加油	<ul style="list-style-type: none"> • 重新加注油箱。 • 清洁导板、链轮和链轮盖。参见 保养和维护 部分。

制造商：百得美国公司

地址：701 E Joppa Rd, TW050 MD21286, Towson, 美国

产地：江苏苏州

