

DEWALT®

XR®

www.DEWALT.com

DCG440

English (*original instructions*)

4

简体中文

18

Fig. A
图 A

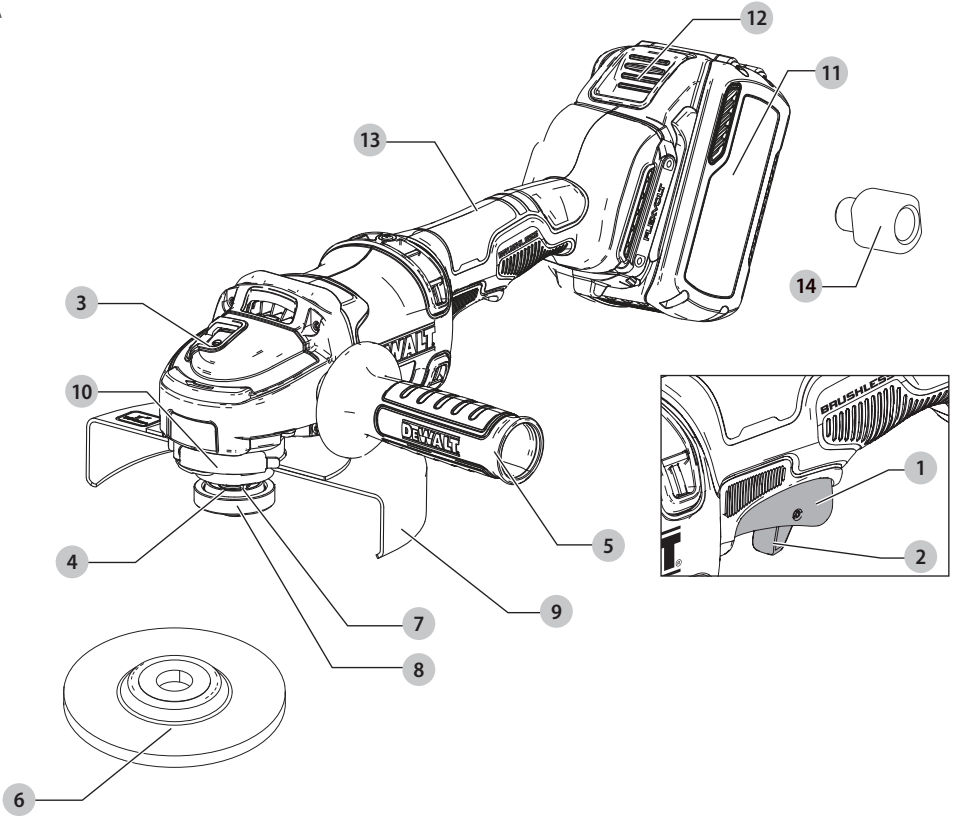

Fig. B
图 B

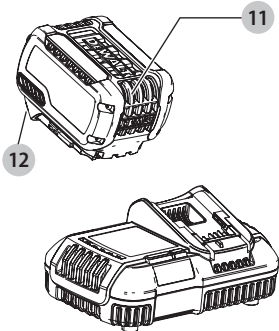

Fig. C
图 C

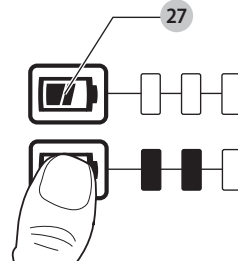

Fig. D
图 D

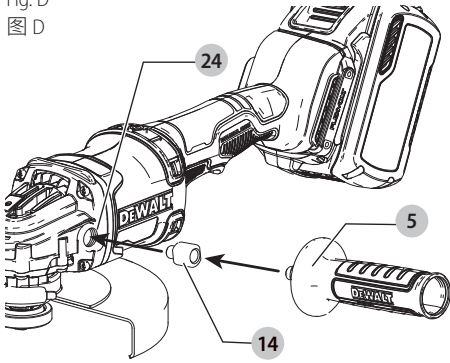

Fig. E
图 E

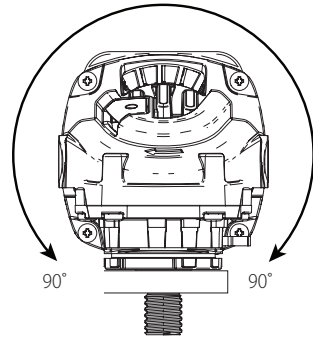

Fig. F
图 F

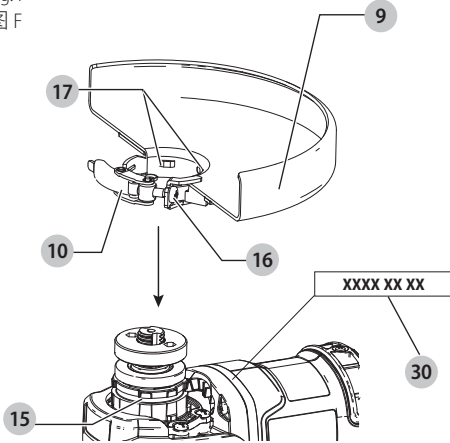

Fig. G
图 G

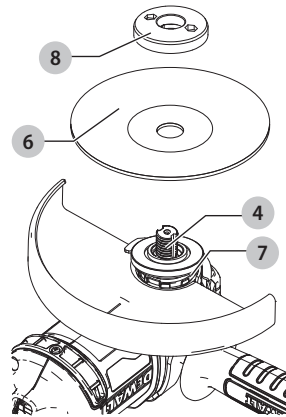

Fig. H
图 H

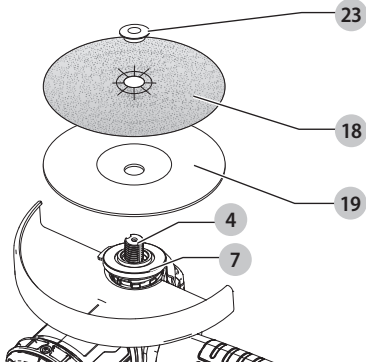

Fig. J
图 J

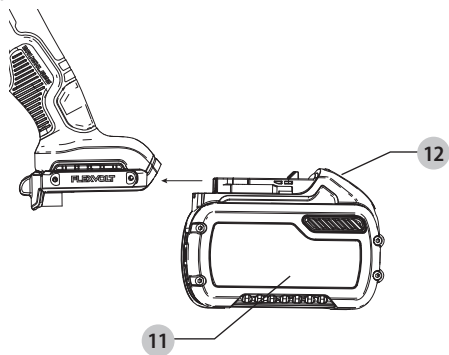

Fig. K
图 K

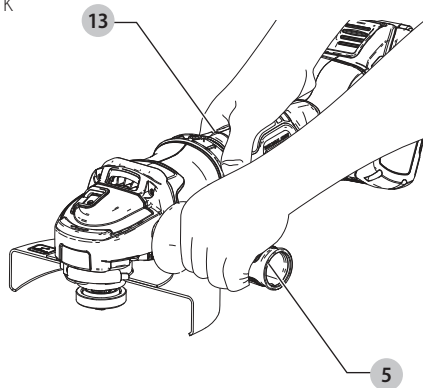

Fig. L
图 L

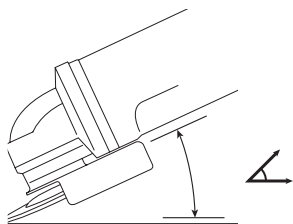

Fig. N
图 N

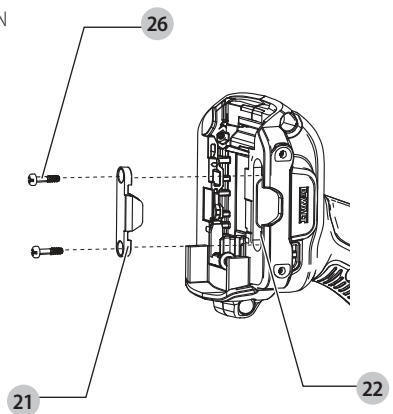
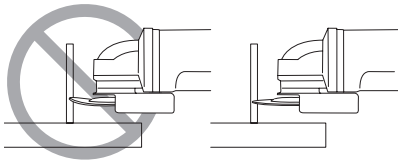

Fig. M
图 M



CORDLESS 180MM ANGLE GRINDER

DCG440

Congratulations!

You have chosen a BernerDEWALT tool. Years of experience, thorough product development and innovation make BernerDEWALT one of the most reliable partners for professional power tool users.

Technical Data

		DCG440
Voltage	V _{DC}	54(60 Max)
Battery type		Li-Ion
Max. Power Output	W	2300
Rated speed	min ⁻¹	6500
Wheel diameter	mm	180
Wheel thickness (max)	mm	8
Spindle diameter		M14
Spindle length	mm	15.3
Weight (without battery pack)	kg	2.7

Batteries				Chargers / Charge Times (Minutes)						
Cat#	V _{DC}	Ah	Weight(kg)	DCB104	DCB107	DCB112 DCB1102	DCB115 DCB1104	DCB117 DCB1112	DCB118	DCB132
DCB546/DCB606	18/54 (20/60 Max)	6.0/2.0	1.08	60	270	170	90	40	60	90
DCB547/DCB609/DCB609G	18/54 (20/60 Max)	9.0/3.0	1.46	75*	420	270	135*	60	75*	135*
DCB548/DCB612	18/54 (20/60 Max)	12.0/4.0	1.46	120	540	350	180	80	120	180
DCB549/DCB615	18/54 (20/60 Max)	15.0/5.0	2.12	125	730	450	230	90	125	230

*Date code 201811475B or later

**Date code 201536 or later



WARNING: To reduce the risk of injury, read the instruction manual.

Definitions: Safety Guidelines

The definitions below describe the level of severity for each signal word. Please read the manual and pay attention to these symbols.



DANGER: Indicates an imminently hazardous situation which, if not avoided, **will** result in **death or serious injury**.



WARNING: Indicates a potentially hazardous situation which, if not avoided, **could** result in **death or serious injury**.



CAUTION: Indicates a potentially hazardous situation which, if not avoided, **may** result in **minor or moderate injury**.



NOTICE: Indicates a practice **not related to personal injury** which, if not avoided, **may** result in **property damage**.



Denotes risk of electric shock.



Denotes risk of fire.

GENERAL POWER TOOL SAFETY WARNINGS



WARNING: Read all safety warnings, instructions, illustrations and specifications provided with this power tool. Failure to follow all instructions listed below may result in electric shock, fire and/or serious injury.

SAVE ALL WARNINGS AND INSTRUCTIONS FOR FUTURE REFERENCE

The term "power tool" in the warnings refers to your mains-operated (corded) power tool or battery-operated (cordless) power tool.

1) Work Area Safety

- a) Keep work area clean and well lit. Cluttered or dark areas invite accidents.
- b) Do not operate power tools in explosive atmospheres, such as in the presence of flammable liquids, gases or dust. Power tools create sparks which may ignite the dust or fumes.
- c) Keep children and bystanders away while operating a power tool. Distractions can cause you to lose control.

2) Electrical Safety

- a) **Power tool plugs must match the outlet. Never modify the plug in any way. Do not use any adapter plugs with earthed (grounded) power tools.** Unmodified plugs and matching outlets will reduce risk of electric shock.
- b) **Avoid body contact with earthed or grounded surfaces, such as pipes, radiators, ranges and refrigerators.** There is an increased risk of electric shock if your body is earthed or grounded.
- c) **Do not expose power tools to rain or wet conditions.** Water entering a power tool will increase the risk of electric shock.
- d) **Do not abuse the cord. Never use the cord for carrying, pulling or unplugging the power tool. Keep cord away from heat, oil, sharp edges or moving parts.** Damaged or entangled cords increase the risk of electric shock.
- e) **When operating a power tool outdoors, use an extension cord suitable for outdoor use.** Use of a cord suitable for outdoor use reduces the risk of electric shock.
- f) **If operating a power tool in a damp location is unavoidable, use a residual current device (RCD) protected supply.** Use of an RCD reduces the risk of electric shock.

3) Personal Safety

- a) **Stay alert, watch what you are doing and use common sense when operating a power tool. Do not use a power tool while you are tired or under the influence of drugs, alcohol or medication.** A moment of inattention while operating power tools may result in serious personal injury.
- b) **Use personal protective equipment. Always wear eye protection.** Protective equipment such as a dust mask, non-skid safety shoes, hard hat or hearing protection used for appropriate conditions will reduce personal injuries.

- c) **Prevent unintentional starting. Ensure the switch is in the off-position before connecting to power source and/or battery pack, picking up or carrying the tool.** Carrying power tools with your finger on the switch or energising power tools that have the switch on invites accidents.
- d) **Remove any adjusting key or wrench before turning the power tool on.** A wrench or a key left attached to a rotating part of the power tool may result in personal injury.
- e) **Do not overreach. Keep proper footing and balance at all times.** This enables better control of the power tool in unexpected situations.
- f) **Dress properly. Do not wear loose clothing or jewellery. Keep your hair and clothing away from moving parts.** Loose clothes, jewellery or long hair can be caught in moving parts.
- g) **If devices are provided for the connection of dust extraction and collection facilities, ensure these are connected and properly used.** Use of dust collection can reduce dust-related hazards.
- h) Do not let familiarity gained from frequent use of tools allow you to become complacent and ignore tool safety principles. A careless action can cause severe injury within a fraction of a second.

4) Power Tool Use and Care

- a) **Do not force the power tool. Use the correct power tool for your application.** The correct power tool will do the job better and safer at the rate for which it was designed.
- b) **Do not use the power tool if the switch does not turn it on and off.** Any power tool that cannot be controlled with the switch is dangerous and must be repaired.
- c) **Disconnect the plug from the power source and/or remove the battery pack, if detachable, from the power tool before making any adjustments, changing accessories, or storing power tools.** Such preventive safety measures reduce the risk of starting the power tool accidentally.
- d) **Store idle power tools out of the reach of children and do not allow persons unfamiliar with the power tool or these instructions to operate the power tool.** Power tools are dangerous in the hands of untrained users.
- e) **Maintain power tools and accessories. Check for misalignment or binding of moving parts, breakage of parts and any other condition that may affect the power tool's operation. If damaged, have the power tool repaired before use.** Many accidents are caused by poorly maintained power tools.
- f) **Keep cutting tools sharp and clean.** Properly maintained cutting tools with sharp cutting edges are less likely to bind and are easier to control.
- g) **Use the power tool, accessories and tool bits etc. in accordance with these instructions, taking into account the working conditions and the work to be performed.** Use of the power tool for operations different from those intended could result in a hazardous situation.

- h) *Keep handles and grasping surfaces dry, clean and free from oil and grease. Slippery handles and grasping surfaces do not allow for safe handling and control of the tool in unexpected situations.*

5) Battery Tool Use and Care

- a) *Recharge only with the charger specified by the manufacturer. A charger that is suitable for one type of battery pack may create a risk of fire when used with another battery pack.*
- b) *Use power tools only with specifically designated battery packs. Use of any other battery packs may create a risk of injury and fire.*
- c) *When battery pack is not in use, keep it away from other metal objects, like paper clips, coins, keys, nails, screws or other small metal objects, that can make a connection from one terminal to another. Shorting the battery terminals together may cause burns or a fire.*
- d) **Under abusive conditions, liquid may be ejected from the battery; avoid contact. If contact accidentally occurs, flush with water.** *If liquid contacts eyes, additionally seek medical help. Liquid ejected from the battery may cause irritation or burns.*
- e) *Do not use a battery pack or tool that is damaged or modified. Damaged or modified batteries may exhibit unpredictable behaviour resulting in fire, explosion or risk of injury.*
- f) *Do not expose a battery pack or tool to fire or excessive temperature. Exposure to fire or temperature above 130 °C may cause explosion.*
- g) *Follow all charging instructions and do not charge the battery pack or tool outside the temperature range specified in the instructions. Charging improperly or at temperatures outside the specified range may damage the battery and increase the risk of fire.*

6) Service

- a) **Have your power tool serviced by a qualified repair person using only identical replacement parts.** *This will ensure that the safety of the power tool is maintained.*
- b) *Never service damaged battery packs. Service of battery packs should only be performed by the manufacturer or authorized service providers.*

ADDITIONAL SPECIFIC SAFETY RULES

Safety Warnings Common for Grinding, Sanding, Wire Brushing or Abrasive Cutting-Off Operations

- a) **This power tool is intended to function as a grinder, sander, wire brush, cut-off tool. Read all safety warnings, instructions, illustrations and specifications provided with this power tool.** *Failure to follow all instructions listed below may result in electric shock, fire and/or serious injury.*
- b) **Operations such as polishing or hole cutting are not to be performed with this power tool.** *Operations*

for which the power tool was not designed may create a hazard and cause personal injury.

- c) **Do not convert this power tool to operate in a way which is not specifically designed and specified by the tool manufacturer.** *Such a conversion may result in a loss of control and cause serious personal injury.*
- d) **Do not use accessories which are not specifically designed and specified by the tool manufacturer.** *Just because the accessory can be attached to your power tool, it does not assure safe operation.*
- e) **The rated speed of the accessory must be at least equal to the maximum speed marked on the power tool.** *Accessories running faster than their rated speed can break and fly apart.*
- f) **The outside diameter and the thickness of your accessory must be within the capacity rating of your power tool.** *Incorrectly sized accessories can not be adequately guarded or controlled.*
- g) **The dimensions of the accessory mounting must fit the dimensions of the mounting hardware of the power tool.** *Accessories that do not match the mounting hardware of the power tool will run out of balance, vibrate excessively and may cause loss of control.*
- h) **Do not use a damaged accessory. Before each use inspect the accessory such as abrasive wheel for chips and cracks, backing pad for cracks, tear or excess wear, wire brush for loose or cracked wires. If power tool or accessory is dropped, inspect for damage or install an undamaged accessory. After inspecting and installing an accessory, position yourself and bystanders away from the plane of the rotating accessory and run the power tool at maximum no-load speed for one minute.** *Damaged accessories will normally break apart during this test time.*
- i) **Wear personal protective equipment. Depending on application, use face shield, safety goggles or safety glasses. As appropriate, wear dust mask, hearing protectors, gloves and workshop apron capable of stopping small abrasive or workpiece fragments.** *The eye protection must be capable of stopping flying debris generated by various operations. The dust mask or respirator must be capable of filtering particles generated by your operation. Prolonged exposure to high intensity noise may cause hearing loss.*
- j) **Keep bystanders a safe distance away from work area. Anyone entering the work area must wear personal protective equipment.** *Fragments of workpiece or of a broken accessory may fly away and cause injury beyond immediate area of operation.*
- k) **Hold the power tool by insulated gripping surfaces only, when performing an operation where the cutting accessory may contact hidden wiring or its own cord.** *Cutting accessory contacting a "live" wire may make exposed metal parts of the power tool "live" and could give the operator an electrical shock.*

- l) **Position the cord clear of the spinning accessory.** If you lose control, the cord may be cut or snagged and your hand or arm may be pulled into the spinning accessory.
- m) **Never lay the power tool down until the accessory has come to a complete stop.** The spinning accessory may grab the surface and pull the power tool out of your control.
- n) **Do not run the power tool while carrying it at your side.** Accidental contact with the spinning accessory could snag your clothing, pulling the accessory into your body.
- o) **Regularly clean the power tool's air vents.** The motor's fan will draw the dust inside the housing and excessive accumulation of powdered metal may cause electrical hazards.
- p) **Do not operate the power tool near flammable materials.** Sparks could ignite these materials.
- q) **Do not use accessories that require liquid coolants.** Using water or other liquid coolants may result in electrocution or shock.

FURTHER SAFETY INSTRUCTIONS FOR ALL OPERATIONS

Kickback and Related Warnings

Kickback is a sudden reaction to a pinched or snagged rotating wheel, backing pad, brush or any other accessory. Pinching or snagging causes rapid stalling of the rotating accessory which in turn causes the uncontrolled power tool to be forced in the direction opposite of the accessory's rotation at the point of the binding.

For example, if an abrasive wheel is snagged or pinched by the workpiece, the edge of the wheel that is entering into the pinch point can dig into the surface of the material causing the wheel to climb out or kick out. The wheel may either jump toward or away from the operator, depending on direction of the wheel's movement at the point of pinching. Abrasive wheels may also break under these conditions.

Kickback is the result of tool misuse and/or incorrect operating procedures or conditions and can be avoided by taking proper precautions as given below:

- a) **Maintain a firm grip on the power tool and position your body and arm to allow you to resist kickback forces.** Always use auxiliary handle, if provided, for maximum control over kickback or torque reaction during start up. The operator can control torque reaction or kickback forces, if proper precautions are taken.
- b) **Never place your hand near the rotating accessory.** Accessory may kickback over your hand.
- c) **Do not position your body in the area where power tool will move if kickback occurs.** Kickback will propel the tool in direction opposite to the wheel's movement at the point of snagging.
- d) **Use special care when working corners, sharp edges etc. Avoid bouncing and snagging the accessory.** Corners, sharp edges or bouncing have a tendency to

snag the rotating accessory and cause loss of control or kickback.

- e) **Do not attach a saw chain woodcarving blade, segmented diamond wheel with a peripheral gap greater than 10 mm or toothed saw blade.** Such blades create frequent kickback and loss of control.

Safety Warnings Specific for Grinding and Cutting-Off Operations

- a) **Use only wheel types that are recommended for your power tool and the specific guard designed for the selected wheel.** Wheels for which the power tool was not designed cannot be adequately guarded and are unsafe.
- b) **The grinding surface of centre depressed wheels must be mounted below the plane of the guard lip.** An improperly mounted wheel that projects through the plane of the guard lip cannot be adequately protected.
- c) **The guard must be securely attached to the power tool and positioned for maximum safety, so the least amount of wheel is exposed towards the operator.** The guard helps to protect the operator from broken wheel fragments, accidental contact with wheel and sparks that could ignite clothing.
- d) **Wheels must be used only for specified applications. For example: do not grind with the side of cut-off wheel.** Abrasive cut-off wheels are intended for peripheral grinding, side forces applied to these wheels may cause them to shatter.
- e) **Always use undamaged wheel flanges that are of correct size and shape for your selected wheel.** Proper wheel flanges support the wheel thus reducing the possibility of wheel breakage. Flanges for cut-off wheels may be different from grinding wheel flanges.
- f) **Do not use worn down wheels from larger power tools.** A wheel intended for larger power tool is not suitable for the higher speed of a smaller tool and may burst.
- g) **When using dual purpose wheels always use the correct guard for the application being performed.** Failure to use the correct guard may not provide the desired level of guarding, which could lead to serious injury.

Additional Safety Warnings Specific for Cutting-Off Operations

- a) **Do not "jam" the cut-off wheel or apply excessive pressure. Do not attempt to make an excessive depth of cut.** Overstressing the wheel increases the loading and susceptibility to twisting or binding of the wheel in the cut and the possibility of kickback or wheel breakage.
- b) **Do not position your body in line with and behind the rotating wheel.** When the wheel, at the point of operations, is moving away from your body, the possible kickback may propel the spinning wheel and the power tool directly at you.

- c) **When wheel is binding or when interrupting a cut for any reason, switch off the power tool and hold the power tool motionless until the wheel comes to a complete stop. Never attempt to remove the cut-off wheel from the cut while the wheel is in motion otherwise kickback may occur.** Investigate and take corrective action to eliminate the cause of wheel binding.
- d) **Do not restart the cutting operation in the workpiece. Let the wheel reach full speed and carefully re-enter the cut.** The wheel may bind, walk up or kickback if the power tool is restarted in the workpiece.
- e) **Support panels or any oversized workpiece to minimize the risk of wheel pinching and kickback.** Large workpieces tend to sag under their own weight. Supports must be placed under the workpiece near the line of cut and near the edge of the workpiece on both sides of the wheel.
- f) **Use extra caution when making a "pocket cut" into existing walls or other blind areas.** The protruding wheel may cut gas or water pipes, electrical wiring or objects that can cause kickback.
- g) **Do not attempt to do curved cutting.** Overstressing the wheel increases the loading and susceptibility to twisting or binding of the wheel in the cut and the possibility of kickback or wheel breakage, which can lead to serious injury.

Additional Safety Instructions for Sanding Operations

- a) **Use proper sized sanding disc paper. Follow manufacturers commendations, when selecting sanding paper.** Larger sanding paper extending too far beyond the sanding pad presents a laceration hazard and may cause snagging, tearing of the disc or kickback.

Additional Safety Instructions for Wire Brushing Operations

- a) **Be aware that wire bristles are thrown by the brush even during ordinary operation. Do not overstress the wires by applying excessive load to the brush.** The wire bristles can easily penetrate light clothing and/or skin.
- b) **If the use of a guard is specified for wire brushing, do not allow any interference of the wire wheel or brush with the guard.** Wire wheel or brush may expand in diameter due to work and centrifugal forces.

Additional Safety Rules for Grinders

- a) **Do not use Type 11 (flaring cup) wheels on this tool.** Using inappropriate accessories can result in injury.
- b) **Always use side handle. Tighten the handle securely.** The side handle should always be used to maintain control of the tool at all times.

Residual Risks

In spite of the application of the relevant safety regulations and the implementation of safety devices, certain residual risks cannot be avoided. These are:

- Impairment of hearing.
- Risk of personal injury due to flying particles.
- Risk of burns due to accessories becoming hot during operation.
- Risk of personal injury due to prolonged use.

SAVE THESE INSTRUCTIONS

Chargers

DEWALT chargers require no adjustment and are designed to be as easy as possible to operate.

Electrical Safety

The electric motor has been designed for one voltage only. Always check that the battery pack voltage corresponds to the voltage on the rating plate. Also make sure that the voltage of your charger corresponds to that of your mains.



Your DEWALT charger is double insulated in accordance with IEC60335; therefore no earth wire is required.

If the supply cord is damaged, it must be replaced only by DEWALT or an authorised service organisation.

Using an Extension Cable

An extension cord should not be used unless absolutely necessary. Use an approved extension cable suitable for the power input of your charger (see **Technical Data**). The minimum conductor size is 1 mm²; the maximum length is 30 m.

When using a cable reel, always unwind the cable completely.

Important Safety Instructions for All Battery Chargers

SAVE THESE INSTRUCTIONS: This manual contains important safety and operating instructions for compatible battery chargers (refer to **Technical Data**).

- Before using charger, read all instructions and cautionary markings on charger, battery pack, and product using battery pack.



WARNING: Shock hazard. Do not allow any liquid to get inside charger. Electric shock may result.



WARNING: We recommend the use of a residual current device with a residual current rating of 30mA or less.



CAUTION: Burn hazard. To reduce the risk of injury, charge only DEWALT rechargeable batteries. Other types of batteries may burst causing personal injury and damage.



CAUTION: Children should be supervised to ensure that they do not play with the appliance.

NOTICE: Under certain conditions, with the charger plugged into the power supply, the exposed charging contacts inside the charger can be shorted by foreign material. Foreign materials of a conductive nature such

as, but not limited to, steel wool, aluminum foil or any buildup of metallic particles should be kept away from charger cavities. Always unplug the charger from the power supply when there is no battery pack in the cavity. Unplug charger before attempting to clean.

- **DO NOT attempt to charge the battery pack with any chargers other than the ones in this manual.** The charger and battery pack are specifically designed to work together.
- **These chargers are not intended for any uses other than charging DEWALT rechargeable batteries.** Any other uses may result in risk of fire, electric shock or electrocution.
- **Do not expose charger to rain or snow.**
- **Pull by plug rather than cord when disconnecting charger.** This will reduce risk of damage to electric plug and cord.
- **Make sure that cord is located so that it will not be stepped on, tripped over, or otherwise subjected to damage or stress.**
- **Do not use an extension cord unless it is absolutely necessary.** Use of improper extension cord could result in risk of fire, electric shock, or electrocution.
- **Do not place any object on top of charger or place the charger on a soft surface that might block the ventilation slots and result in excessive internal heat.** Place the charger in a position away from any heat source. The charger is ventilated through slots in the top and the bottom of the housing.
- **Do not operate charger with damaged cord or plug—** have them replaced immediately.
- **Do not operate charger if it has received a sharp blow, been dropped, or otherwise damaged in any way.** Take it to an authorised service centre.
- **Do not disassemble charger; take it to an authorised service centre when service or repair is required.** Incorrect reassembly may result in a risk of electric shock, electrocution or fire.
- **In case of damaged power supply cord, the supply cord must be replaced immediately by the manufacturer, its service agent or similar qualified person to prevent any hazard.**
- **Disconnect the charger from the outlet before attempting any cleaning.** This will reduce the risk of electric shock. Removing the battery pack will not reduce this risk.
- **NEVER attempt to connect two chargers together.**
- **The charger is designed to operate on standard 220-240V household electrical power. Do not attempt to use it on any other voltage.** This does not apply to the vehicular charger.

Charging a Battery (Fig. B)

NOTE: Refer to the label near indicator light(s) on charger for on/off and blink patterns. Older chargers may have additional information and/or may not have a yellow indicator light, being equipped with only a single red indicator light.

1. Plug the charger into an appropriate outlet before inserting battery pack.

2. Insert and fully seat battery pack. The left indicator light will continuously blink red to indicate that the charging process has started. For two-stage chargers, this is indicative of Stage 1 charging during which the battery pack is charged to a majority of its capacity.
3. Charging is complete for a single-stage charger when the left indicator light remains continuously red and the right indicator light stays unlit. For a two-stage charger, the left indicator light remains continuously red and the right indicator light continuously blinks red to indicate stage 2 charging during which the battery pack is topped off to its full capacity. Stage 2 charging is complete when both indicator lights remain continuously red. After charging is complete, the battery pack may be removed and used, or left in the charger.

The charger will not charge a faulty battery pack. The charger refusing to light could indicate a problem with the charger or a faulty battery pack. Discontinue use and take both to an authorised service centre.

NOTE: To remove the battery pack, some chargers require the battery pack release button to be pressed.

WARNING: Only charge batteries in air temperature over 4 °C and below 40 °C.

Single Stage Charger Indicators		
	Charging	
	Fully Charged	
	Hot/Cold Pack Delay	
Two Stage Charger Indicators		
	Stage 1 Charging	
	Stage 2 Charging	
	Fully Charged	
	Hot/Cold Pack Delay	

Hot/Cold Pack Delay

When the charger detects a battery pack that is too hot or too cold, it automatically starts a Hot/Cold Pack Delay, suspending charging until the battery pack has reached an appropriate temperature. The charger then automatically switches to the pack charging mode. This feature ensures maximum battery pack life.

A cold battery pack will charge at a slower rate than a warm battery pack. The battery pack will charge at that slower rate throughout the entire charging cycle and will not return to maximum charge rate even if the battery pack warms.

Some chargers are equipped with an internal fan designed to cool the battery pack. The fan will turn on automatically when the battery pack needs to be cooled. Never operate the charger if the fan does not operate properly or if ventilation slots are

blocked. Do not permit foreign objects to enter the interior of the charger.

Electronic Protection System

XR Li-Ion tools are designed with an Electronic Protection System that will protect the battery pack against overloading, overheating or deep discharge.

The tool will automatically turn off if the Electronic Protection System engages. If this occurs, place the lithium-ion battery pack on the charger until it is fully charged.

Wall Mounting

These chargers are designed to be wall mountable or to sit upright on a table or work surface. If wall mounting, locate the charger within reach of an electrical outlet, and away from a corner or other obstructions which may impede air flow. Use the back of the charger as a template for the location of the mounting screws on the wall. Mount the charger securely using drywall screws (purchased separately) at least 25.4 mm long with a screw head diameter of 7–9 mm, screwed into wood to an optimal depth leaving approximately 5.5 mm of the screw exposed. Align the slots on the back of the charger with the exposed screws and fully engage them in the slots.

Charger Cleaning Instructions



WARNING: Shock hazard. Disconnect the charger from the AC outlet before cleaning. Dirt and grease may be removed from the exterior of the charger using a cloth or soft non-metallic brush. Do not use water or any cleaning solutions. Never let any liquid get inside the tool; never immerse any part of the tool into a liquid.

Battery Packs

Important Safety Instructions for All Battery Packs

When ordering replacement battery packs, be sure to include catalogue number and voltage.

The battery pack is not fully charged out of the carton. Before using the battery pack and charger, read the safety instructions below. Then follow charging procedures outlined.

READ ALL INSTRUCTIONS

- **Do not charge or use battery in explosive atmospheres, such as in the presence of flammable liquids, gases or dust.** Inserting or removing the battery from the charger may ignite the dust or fumes.
- **Never force battery pack into charger. Do not modify battery pack in any way to fit into a non-compatible charger as battery pack may rupture causing serious personal injury.**
- **Charge the battery packs only in DEWALT chargers.**
- **DO NOT splash or immerse in water or other liquids.**
- **Do not store or use the tool and battery pack in locations where the temperature may fall below 4 °C (39.2 °F) (such as outside sheds or metal buildings in winter), or reach or exceed 40 °C (104 °F) (such as outside sheds or metal buildings in summer).**

- **Do not incinerate the battery pack even if it is severely damaged or is completely worn out.** The battery pack can explode in a fire. Toxic fumes and materials are created when lithium-ion battery packs are burned.
- **If battery contents come into contact with the skin, immediately wash area with mild soap and water.** If battery liquid gets into the eye, rinse water over the open eye for 15 minutes or until irritation ceases. If medical attention is needed, the battery electrolyte is composed of a mixture of liquid organic carbonates and lithium salts.
- **Contents of opened battery cells may cause respiratory irritation.** Provide fresh air. If symptoms persists, seek medical attention.



WARNING: Burn hazard. Battery liquid may be flammable if exposed to spark or flame.



WARNING: Never attempt to open the battery pack for any reason. If battery pack case is cracked or damaged, do not insert into charger. Do not crush, drop or damage battery pack. Do not use a battery pack or charger that has received a sharp blow, been dropped, run over or damaged in any way (i.e., pierced with a nail, hit with a hammer, stepped on). Electric shock or electrocution may result. Damaged battery packs should be returned to service centre for recycling.



WARNING: Fire hazard. Do not store or carry the battery pack so that metal objects can contact exposed battery terminals. For example, do not place the battery pack in aprons, pockets, tool boxes, product kit boxes, drawers, etc., with loose nails, screws, keys, etc.



CAUTION: When not in use, place tool on its side on a stable surface where it will not cause a tripping or falling hazard. Some tools with large battery packs will stand upright on the battery pack but may be easily knocked over.

Transportation



WARNING: Fire hazard. Transporting batteries can possibly cause fire if the battery terminals inadvertently come in contact with conductive materials. When transporting batteries, make sure that the battery terminals are protected and well insulated from materials that could contact them and cause a short circuit. **NOTE:** Lithium-ion batteries should not be put in checked baggage.

DEWALT batteries comply with all applicable shipping regulations as prescribed by industry and legal standards which include UN Recommendations on the Transport of Dangerous Goods; International Air Transport Association (IATA) Dangerous Goods Regulations, International Maritime Dangerous Goods (IMDG) Regulations, and the European Agreement Concerning The International Carriage of Dangerous Goods by Road (ADR). Lithium-ion cells and batteries have been tested to section 38.3 of the UN Recommendations on the Transport of Dangerous Goods Manual of Tests and Criteria.

In most instances, shipping a DEWALT battery pack will be excepted from being classified as a fully regulated Class

9 Hazardous Material. In general, only shipments containing a lithium-ion battery with an energy rating greater than 100 Watt Hours (Wh) will require being shipped as fully regulated Class 9. All lithium-ion batteries have the Watt Hour rating marked on the pack. Furthermore, due to regulation complexities, DeWALT does not recommend air shipping lithium-ion battery packs alone regardless of Watt Hour rating. Shipments of tools with batteries (combo kits) can be air shipped as excepted if the Watt Hour rating of the battery pack is no greater than 100 Wh.

Regardless of whether a shipment is considered excepted or fully regulated, it is the shipper's responsibility to consult the latest regulations for packaging, labeling/marketing and documentation requirements.

The information provided in this section of the manual is provided in good faith and believed to be accurate at the time the document was created. However, no warranty, expressed or implied, is given. It is the buyer's responsibility to ensure that its activities comply with the applicable regulations.

Storage Recommendations

1. The best storage place is one that is cool and dry away from direct sunlight and excess heat or cold. For optimum battery performance and life, store battery packs at room temperature when not in use.
2. For long storage, it is recommended to store a fully charged battery pack in a cool, dry place out of the charger for optimal results.

NOTE: Battery packs should not be stored completely depleted of charge. The battery pack will need to be recharged before use.

Labels on Charger and Battery Pack

In addition to the pictographs used in this manual, the labels on the charger and the battery pack may show the following pictographs:



Read instruction manual before use.



See **Technical Data** for charging time.



Do not probe with conductive objects.



Do not charge damaged battery packs.



Do not expose to water.



Have defective cords replaced immediately



Charge only between 4 °C and 40 °C.



Only for indoor use.



Discard the battery pack with due care for the environment.



Charge DeWALT battery packs only with designated DeWALT chargers. Charging battery packs other than the designated DeWALT batteries with a DeWALT charger may make them burst or lead to other dangerous situations.



Do not incinerate the battery pack.

Battery Type

The following tools operate on a 54(60 Max) volt battery pack: DCG440 .

Refer to **Technical Data** for more battery information.

Package Contents

The package contains:

- 1 Angle grinder(include pipeline cover)
- 1 180 mm Guard (Type 27)
- 1 Side handle
- 1 Side handle extension
- 1 Hex wrench
- 1 charger ((not included with "N" or "NT" models)
- Li-Ion battery packs ((not included with "N" or "NT" models)
- 1 Instruction manual

NOTE: Battery packs, chargers and kitboxes are not included with N models. Battery packs and chargers are not included with NT models. B models include Bluetooth® battery packs.

NOTE: The Bluetooth® word mark and logos are registered trademarks owned by the Bluetooth®, SIG, Inc. and any use of such marks by DeWALT is under license. Other trademarks and trade names are those of their respective owners.

- Check for damage to the tool, parts or accessories which may have occurred during transport.
- Take the time to thoroughly read and understand this manual prior to operation.

Markings on Tool

The following pictograms are shown on the tool:



Read instruction manual before use.



Wear ear protection.



Wear eye protection.



Visible radiation. Do not stare into light.

Date Code Position (Fig. F)

The date code **30**, which also includes the year of manufacture, is printed into the housing.

Description (Fig. A)



WARNING: Never modify the power tool or any part of it. Damage or personal injury could result.

- 1 Trigger switch
- 2 Lock-off lever
- 3 Spindle lock button
- 4 Spindle
- 5 Auxiliary handle
- 6 Grinding wheel
- 7 Unthreaded backing flange (fixed to spindle)
- 8 Locking flange
- 9 Type 27 Guard 7" (180 mm)
- 10 Guard release lever
- 11 Battery pack
- 12 Battery release button
- 13 Main Handle
- 14 Side handle extension

Intended Use

The DCG440 cordless angle grinder has been designed for professional cutting, grinding, sanding and wire brush applications.

DO NOT use under wet conditions or in the presence of flammable liquids or gases.

This cordless angle grinder is a professional power tool.

DO NOT let children come into contact with the tool. Supervision is required when inexperienced operators use this tool.

- **Young children and the infirm.** This appliance is not intended for use by young children or infirm persons without supervision.
- This product is not intended for use by persons (including children) suffering from diminished physical, sensory or mental abilities; lack of experience, knowledge or skills unless they are supervised by a person responsible for their safety. Children should never be left alone with this product.

Assembly and adjustments



WARNING: To reduce the risk of serious personal injury, turn tool off and disconnect battery pack before making any adjustments or removing/installing attachments or accessories. An accidental start-up can cause injury.



WARNING: Use only DEWALT battery packs and chargers.

Features

E-Clutch™

This unit is equipped with an E-Clutch™ (Electronic Clutch), which in the event of a high-load the unit will be shut off to reduce the reaction torque to the user. The switch needs to be cycled (turned on and off) to restart tool.

Kickback Brake™

When a pinch, stall, or bind-up event is sensed the electronic brake engages with maximum force to quickly stop the wheel, reduce the movement of the grinder, and shut the grinder off. The switch needs to be cycled (turned on and off) to restart the tool.

Power-OFF™ OVERLOAD Protection

The power supply to the motor will be reduced in case of motor overload. With continued motor overload, the tool will shut off. The switch needs to be cycled (turned on and off) to restart tool. The tool will power off each time the current load reaches the overload current value (motor burn-up point). If continued overload shutdowns occur, apply less force/weight on the tool until the tool will function without the overload engaging.

Electronic Soft Start

This feature limits the initial start up speed, allowing the tool to build up to full speed gradually over a 1 second period.

Inserting and Removing the Battery Pack from the Tool (Fig. J)

NOTE: Make sure your battery pack **11** is fully charged.

To Install the Battery Pack into the Tool Handle

1. Align the battery pack **11** with the rails inside the tool's handle (Fig. J).
2. Slide it into the handle until the battery pack is firmly seated in the tool and ensure that you hear the lock snap into place.

To Remove the Battery Pack from the Tool

1. Press the release button **12** and firmly pull the battery pack out of the tool handle.
2. Insert battery pack into the charger as described in the charger section of this manual.

Fuel Gauge Battery Packs (Fig. C)

Some DEWALT battery packs include a fuel gauge which consists of three green LED lights that indicate the level of charge remaining in the battery pack.

To actuate the fuel gauge, press and hold the fuel gauge button **27**. A combination of the three green LED lights will illuminate designating the level of charge left. When the level of charge in the battery is below the usable limit, the fuel gauge will not illuminate and the battery will need to be recharged.

NOTE: The fuel gauge is only an indication of the charge left on the battery pack. It does not indicate tool functionality and is subject to variation based on product components, temperature and end-user application.

Attaching the Auxiliary Handle (Fig. D)



WARNING: This handle **SHOULD BE USED AT ALL TIMES** to maintain complete control of the tool. Always make sure the handle is tight.

Screw the auxiliary handle **5** tightly into one of the threaded mounting holes of the gear case.

Rotating the Gear Case (Fig. E)

To improve user comfort, the gear case will rotate 90° for cutting operations.

1. Remove the four corner screws attaching the gear case to motor housing.
2. Without separating the gear case from motor housing, rotate the gear case head to desired position.

NOTE: If the gear case and motor housing become separated by more than 3 mm, the tool must be serviced and re-assembled by a DeWALT service center. Failure to have the tool serviced may motor and bearing failure.

3. Reinstall screws to attach the gear case to the motor housing. Tighten screws to 12.5 in.-lbs. torque. Overtightening could cause screws to strip.

Guards



CAUTION: Guards must be used with all grinding wheels, cutting wheels, sanding flap discs, wire brushes, and wire wheels. The tool may be used without a guard only when sanding with conventional sanding discs. Refer to Figure A to see guards provided with the unit. Some applications may require purchasing the correct guard from your local dealer or authorized service center.

NOTE: Edge grinding and cutting can be performed with Type 27 wheels designed and specified for this purpose; 6 mm (1/4") thick wheels are designed for surface grinding while thinner Type 27 wheels need to be examined for the manufacturer's label to see if they can be used for surface grinding or only edge grinding/cutting. A Type 1/41 guard must be used for any wheel where surface grinding is forbidden. Cutting can also be performed by using a Type 1/41 wheel and a Type 1/41 guard.

NOTE: See the **Accessories Chart** to select the proper guard / accessory combination.

Mounting and Removing Guard (Fig. F)



CAUTION: Guards must be used with all grinding wheels, cut-off wheels, diamond coated wheels, sanding flap discs, wire brushes, and wire wheels. The tool may be used without a guard only when sanding with conventional sanding discs. Some DeWALT models are provided with a guard intended for use with depressed center wheels (Type 27) and hubbed grinding wheels (Type 27). The same guard is designed for use with sanding flap discs (Type 27 and 29) and wire brushes. Grinding and cutting with wheels other than Type 27 and 29 require different accessory guards not included with tool. Mounting instructions for these accessory guards are included in the accessory package.

1. Open the guard release lever **10**. Align the lugs **17** on the guard with the slots **15** on the gear case.
2. Push the guard down until the guard lugs engage and rotate freely in the groove on the gear case hub.
3. With the guard latch open, rotate the guard **9** into the desired working position. The guard body should be positioned between the spindle and the operator to provide maximum operator protection.

4. Close the guard latch to secure the guard on the gear case. You should not be able to rotate the guard by hand when the latch is closed. Do not operate the grinder with a loose guard or the clamp lever in open position.
5. To remove the guard, open the guard latch, rotate the guard so that the arrows are aligned and pull up on the guard.

NOTE: The guard is pre-adjusted to the diameter of the gear case hub at the factory. If, after a period of time, the guard becomes loose, tighten the adjusting screw **16** with clamp lever in the closed position.



CAUTION: Do not tighten the adjusting screw with the clamp lever in open position. Undetectable damage to the guard or the mounting hub may result.



CAUTION: If guard cannot be tightened by adjusting clamp, do not use tool and take the tool and guard to a service center to repair or replace the guard.

Flanges and Wheels



WARNING: To reduce the risk of serious personal injury, turn unit off and remove the battery pack before making any adjustments or removing/installing attachments or accessories. An accidental can cause injury.

Mounting Non-Hubbed Wheels (Fig. G)



WARNING: Failure to properly seat the flanges and/or wheel could result in serious injury (or damage to the tool or wheel).



CAUTION: Included flanges must be used with depressed center Type 27/42 grinding wheels and Type 1/41 cutting wheels. Refer to the **Accessories Chart** for more information.



WARNING: A closed, two-sided cutting wheel guard is required when using abrasive cutting wheels or diamond coated cutting wheels.



WARNING: Use of a damaged flange or guard or failure to use proper flange and guard can result in injury due to wheel breakage and wheel contact. Refer to the **Accessories Chart** for more information.

1. Place the tool on a table, guard up.
2. Place wheel **6** against the backing flange **7**, centering the wheel on the raised center (pilot) of the backing flange.
3. While depressing the spindle lock button and with the hex depressions facing away from the wheel, thread the threaded locking flange **8** on spindle so that the lugs engage the two slots in the spindle.
4. While depressing the spindle lock button, tighten the threaded locking flange **8** using a hex wrench.
5. To remove the wheel, depress the spindle lock button and loosen the threaded locking flange.

Mounting Sanding Backing Pads (Fig. A, H)

NOTE: Use of a guard with sanding discs that use backing pads, often called fiber resin discs, is not required. Since a guard is not required for these accessories, the guard may or may not fit correctly if used.

! **WARNING:** Failure to properly seat the clamp nut and/or pad could result in serious injury (or damage to the tool or wheel).

! **WARNING:** Proper guard must be reinstalled for grinding wheel, cutting wheel, sanding flap disc, wire brush or wire wheel applications after sanding applications are complete.

1. Place or appropriately thread backing pad **19** on the spindle.
2. Place the sanding disc **18** on the backing pad **19**.
3. While depressing spindle lock button **3**, thread the sanding clamp nut **23** on spindle, piloting the raised hub on the clamp nut into the center of sanding disc and backing pad.
4. Tighten the clamp nut by hand. Then depress the spindle lock button while turning the sanding disc until the sanding disc and clamp nut are snug.
5. To remove the wheel, grasp and turn the backing pad and sanding pad while depressing the spindle lock button.

Prior to Operation

- Install the guard and appropriate disc or wheel. Do not use excessively worn discs or wheels.
- Be sure the threaded locking flange are mounted correctly. Follow the instructions given in the **Accessories Chart**.
- Make sure the disc or wheel rotates in the direction of the arrows on the accessory and the tool.
- Do not use a damaged accessory. Before each use inspect the accessory such as abrasive wheels for chips and cracks, backing pad for cracks, tear or excess wear, wire brush for loose or cracked wires. If power tool or accessory is dropped, inspect for damage or install an undamaged accessory. After inspecting and installing an accessory, position yourself and bystanders away from the plane of the rotating accessory and run the power tool at maximum no-load speed for one minute. Damaged accessories will normally break apart during this test time.

Operation

Instructions for Use

! **WARNING:** Always observe the safety instructions and applicable regulations.

! **WARNING:** To reduce the risk of serious personal injury, turn tool off and disconnect battery pack before making any adjustments or removing/ installing attachments or accessories. An accidental start-up can cause injury.

Proper Hand Position (Fig. K)

! **WARNING:** To reduce the risk of serious personal injury, ALWAYS use proper hand position as shown.

! **WARNING:** To reduce the risk of serious personal injury, ALWAYS hold securely in anticipation of a sudden reaction.

Proper hand position requires one hand on the main handle **13** and the other hand on the auxiliary handle **5**, as shown in Figure K.

Trigger Switch and Lock-off Lever (Fig. A)

! **WARNING:** Before using the tool, check that the auxiliary handle is tightened securely.

! **WARNING:** Hold the auxiliary handle and main handle of the tool firmly to maintain control of the tool at start up and during use and until the wheel or accessory stops rotating. Make sure the wheel has come to a complete stop before laying the tool down.

1. To turn the tool on, push the lock-off lever **2** toward the back of the tool, then depress the trigger switch **1**. The tool will run while the switch is depressed.
2. Turn the tool off by releasing the releasing switch.

! **WARNING:** Allow the tool to reach full speed before touching tool to the work surface. Lift the tool from the work surface before turning the tool off.

NOTE: This tool has no provision to lock the switch in the ON position, and should never be locked ON by any other means.

Spindle Lock (Fig. A)

The spindle lock button **3** is provided to prevent the spindle from rotating when installing or removing wheels. Operate the spindle lock only when the tool is turned off, the battery is removed and has come to a complete stop.

NOTICE: To reduce the risk of damage to the tool, do not engage the spindle lock while the tool is operating. Damage to the tool will result and attached accessory may spin off possibly resulting in injury.

To engage the lock, depress the spindle lock button and rotate the spindle until you are unable to rotate the spindle further.

Surface Grinding, Sanding and Wire Brushing (Fig. L)

! **CAUTION:** Always use the correct guard per the instructions in this manual.

To perform work on the surface of a workpiece:

1. Allow the tool to reach full speed before touching the tool to the work surface.
2. Apply minimum pressure to the work surface, allowing the tool to operate at high speed. Material removal rate is greatest when the tool operates at high speed.
3. Maintain an appropriate angle between the tool and work surface. Refer to the chart according to particular function.

Function	Angle \angle
Grinding	20°-30°
Sanding with Flap Disc	5°-10°
Sanding with Backing Pad	5°-15°
Wire Brushing	5°-10°

4. Maintain contact between the edge of the wheel and the work surface.
 - If grinding, sanding with flap discs or wire brushing move the tool continuously in a forward and back motion to avoid creating gouges in the work surface.

- If sanding with a backing pad, move the tool constantly in a straight line to prevent burning and swirling of work surface.

NOTE: Allowing the tool to rest on the work surface without moving will damage the workpiece.

5. Remove the tool from work surface before turning tool off. Allow the tool to stop rotating before laying it down.

 **CAUTION:** Use extra care when working over an edge, as a sudden sharp movement of grinder may be experienced.

Precautions To Take When Working on a Painted Workpiece

1. Sanding or wire brushing of lead based paint is NOT RECOMMENDED due to the difficulty of controlling the contaminated dust. The greatest danger of lead poisoning is to children and pregnant women.
2. Since it is difficult to identify whether or not a paint contains lead without a chemical analysis, we recommend the following precautions when sanding any paint:

Personal Safety

1. No children or pregnant women should enter the work area where the paint sanding or wire brushing is being done until all clean up is completed.
2. A dust mask or respirator should be worn by all persons entering the work area. The filter should be replaced daily or whenever the wearer has difficulty breathing.

NOTE: Only those dust masks suitable for working with lead paint dust and fumes should be used. Ordinary painting masks do not offer this protection. See your local hardware dealer for the proper N.I.O.S.H. approved mask.
3. NO EATING, DRINKING or SMOKING should be done in the work area to prevent ingesting contaminated paint particles. Workers should wash and clean up BEFORE eating, drinking or smoking. Articles of food, drink, or smoking should not be left in the work area where dust would settle on them.

Environmental Safety

1. Paint should be removed in such a manner as to minimize the amount of dust generated.
2. Areas where paint removal is occurring should be sealed with plastic sheeting of 4 mils thickness.
3. Sanding should be done in a manner to reduce tracking of paint dust outside the work area.

Cleaning and Disposal

1. All surfaces in the work area should be vacuumed and thoroughly cleaned daily for the duration of the sanding project. Vacuum filter bags should be changed frequently.
2. Plastic drop cloths should be gathered up and disposed of along with any dust chips or other removal debris. They should be placed in sealed refuse receptacles and disposed of through regular trash pick-up procedures. During clean up, children and pregnant women should be kept away from the immediate work area.
3. All toys, washable furniture and utensils used by children should be washed thoroughly before being used again.

Edge Grinding and Cutting (Fig. M)

 **WARNING:** Do not use edge grinding/cutting wheels for surface grinding applications because these wheels are not designed for side pressures encountered with surface grinding. Wheel breakage and injury may result.

 **CAUTION:** Wheels used for edge grinding and cutting may break or kick back if they bend or twist while the tool is being used. In all edge grinding/cutting operations, the open side of the guard must be positioned away from the operator.

NOTE: Edge grinding/cutting with a Type 27 wheel must be limited to shallow cutting and notching—less than 13 mm (1/2") in depth when the wheel is new. Reduce the depth of cutting/notching equal to the reduction of the wheel radius as it wears down. Refer to the **Accessories Chart** for more information. Edge grinding/cutting with a Type 41 wheel requires usage of a Type 1 guard.

1. Allow the tool to reach full speed before touching the tool to the work surface.
2. Apply minimum pressure to the work surface, allowing the tool to operate at high speed. Grinding/cutting rate is greatest when the tool operates at high speed.
3. Position yourself so that the open-underside of the wheel is facing away from you.
4. Once a cut is begun and a notch is established in the workpiece, do not change the angle of the cut. Changing the angle will cause the wheel to bend and may cause wheel breakage. Edge grinding wheels are not designed to withstand side pressures caused by bending.
5. Remove the tool from the work surface before turning the tool off. Allow the tool to stop rotating before laying it down.

MAINTENANCE

Your power tool has been designed to operate over a long period of time with a minimum of maintenance. Continuous satisfactory operation depends upon proper tool care and regular cleaning.

 **WARNING:** To reduce the risk of serious personal injury, turn tool off and disconnect battery pack before making any adjustments or removing/installing attachments or accessories. An accidental start-up can cause injury.

The charger and battery pack are not serviceable.



Lubrication

Your power tool requires no additional lubrication.



Cleaning



WARNING: Blow dirt and dust out of the main housing with dry air as often as dirt is seen collecting in and around the air vents. Wear approved eye protection and approved dust mask when performing this procedure.



WARNING: Never use solvents or other harsh chemicals for cleaning the non-metallic parts of the tool. These chemicals may weaken the materials used in these parts. Use a cloth dampened only with water and mild soap. Never let any liquid get inside the tool; never immerse any part of the tool into a liquid.

Optional Accessories



WARNING: Since accessories, other than those offered by BernerDeWALT, have not been tested with this product, use of such accessories with this tool could be hazardous. To reduce the risk of injury, only BernerDeWALT recommended accessories should be used with this product.

Consult your dealer for further information on the appropriate accessories.

The capacity of this tool is 180 mm (7") diameter x 6 mm (1/4") thick grinding or cutting wheels. It is important to choose the correct guards, backing pads and flanges to use with grinder accessories. See the **Accessories Chart** for information on choosing the correct accessories.



WARNING: Accessories must be rated for at least the speed recommended on the tool warning label. Wheels and other accessories running over their rated accessory speed may fly apart and cause injury. Threaded accessories must have a M14 hub. Every unthreaded accessory must have a 22 mm (7/8") arbor hole. If it does not, it may have been designed for a circular saw. Use only the accessories shown in the **Accessories Chart** of this manual. Accessory ratings must always be above tool speed as shown on tool nameplate.



WARNING: Handle and store all abrasive wheels carefully to prevent damage from thermal shock, heat, mechanical damage, etc. Store in a dry protected area free from high humidity, freezing temperatures or extreme temperature changes.

Tool Connect™ Chip (Fig. N)



WARNING: To reduce the risk of serious personal injury, turn unit off and disconnect it from power source and lock off the tool remove the battery pack before making any adjustments or removing/ installing attachments or accessories. An accidental start-up can cause injury.

Your tool is Tool Connect™ Chip ready and has a location for installation of a Tool Connect™ Chip.

Tool Connect™ Chip is an optional application for your smart device (such as a smart phone or tablet) that connects the device to utilize the mobile application for inventory management functions.

Refer to **Tool Connect™ Chip Instruction Sheet** for more information.

Installing the Tool Connect™ Chip

1. Remove the retaining screws **26** that hold the Tool Connect™ Chip protective cover **21** into the tool.
2. Remove the protective cover and insert the Tool Connect™ Chip into the empty pocket **22**.
3. Ensure that the Tool Connect™ Chip is flush with the housing. Secure it with the retaining screws and tighten the screws.
4. Refer to **Tool Connect™ Chip Instruction Sheet** for further instructions.

Protecting the Environment



Separate collection. Products and batteries marked with this symbol must not be disposed of with normal household waste.

Products and batteries contain materials that can be recovered or recycled reducing the demand for raw materials. Please recycle electrical products and batteries according to local provisions. Further information is available at www.2helpU.com.

Rechargeable Battery Pack



This long life battery pack must be recharged when it fails to produce sufficient power on jobs which were easily done before. At the end of its technical life, discard it with due care for our environment:





- Run the battery pack down completely, then remove it from the tool.
- Li-Ion cells are recyclable. Take them to your dealer or a local recycling station. The collected battery packs will be recycled or disposed of properly.



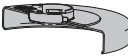

After Service and Repair



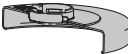

DeWALT service centers are staffed with trained personnel to provide customers with efficient and reliable product service. We do not take any responsibility when you have repaired in unauthorized service center. You can refer to the leaflet of CONTACT CENTER LOCATOR in product package and contact us through hotline, website or social media to find the nearest DeWALT service center around you.





DCG440 ACCESSORIES CHART





Approved wheels for use with DCG440	
Type 1 / T1	
Type 27 / T27	
Non-approved wheels for DCG440	
Type 11 / T11	

Type 27 Depressed Center Grinding Wheels		
Type 27 guard (Shallow)		
Type 27 depressed center wheel		
Locking flange		

Non-Hubbed Sanding Flap Discs		
Type 27 guard (Shallow)		
Non-Hubbed sanding flap disc		
Locking flange		

Type 1/41 Cutting Wheels		
Type 1/41 guard**		
Type 1/41 abrasive cutting wheel		
Locking flange		

Diamond Cutting Wheels		
Type 1/41 guard**		
Diamond cutting wheel		
Locking flange		

Sanding Discs		
Rubber backing pad**		
Sanding disc		
Sanding clamp nut (Included with rubber backing pad**)		
Hubbed Wheel Wrench		
Hubbed wheel wrench**		

! *Type 1/41 guards are intended for use with Type 1/41 cutting wheels and Type 27 wheels marked for cutting only. Grinding with wheels other than Type 27 and Type 29 require different accessory guards. Always use the smallest proper guard possible that does not contact the accessory.*

**** NOTE:** Available at extra cost from your local dealer or authorized service center.

锂电无刷角磨机

DCG440

恭喜!

您选择了一款DeWALT工具。凭借多年的产品开发和创新能力，DeWALT已经成为专业电动工具用户最可靠的合作伙伴之一。

技术数据

		DCG440
电压	V_{dc}	54 (最大60)
电池包类型		锂离子
最大输出功率	W	2300
额定转速	min^{-1}	6500
砂轮直径	mm	180
砂轮厚度 (最大值)	mm	8
主轴直径		M14
主轴长度	mm	15.3
重量 (不含电池包)	kg	2.7

电池包				充电器/充电时间 (分钟)						
型号	V_{dc}	Ah	Weight(kg)	DCB104	DCB107	DCB112 DCB1102	DCB115 DCB1104	DCB117 DCB1112	DCB118	DCB132
DCB546/DCB606	18/54 (20/60 Max)	6.0/2.0	1.08	60	270	170	90	40	60	90
DCB547/DCB609/DCB609G	18/54 (20/60 Max)	9.0/3.0	1.46	75*	420	270	135*	60	75*	135*
DCB548/DCB612	18/54 (20/60 Max)	12.0/4.0	1.46	120	540	350	180	80	120	180
DCB549/DCB615	18/54 (20/60 Max)	15.0/5.0	2.12	125	730	450	230	90	125	230

*日期码 201811475B 或以后

**日期码 201536 或以后



警告: 为降低伤害风险, 请阅读使用手册。

定义: 安全指南

下列定义描述了各标志术语的严重程度。请仔细阅读本手册, 并注意这些标志。



危险: 表示存在紧急危险情况, 如果不加以避免, 将导致死亡或重伤。



警告: 表示存在潜在的危險情况, 如果不加以避免, 可能导致死亡或严重伤害。



小心: 表示存在潜在危險情况, 如果不加以避免, 可能导致轻度或中度伤害。



注意: 表示存在不涉及人身伤害的情况, 如果不加以避免, 可能导致财产损失。



表示存在触电风险。



表示存在火灾风险。

电动工具通用安全警告



警告: 请阅读本电动工具随附的所有安全警告、说明、图示和规定。未能遵照以下所列说明会导致电击、火灾和/或严重伤害。

保存所有警告和说明书以备查阅

警告中的术语“电动工具”指市电驱动（有线）电动工具或电池驱动（无线）电动工具。

1) 工作场地的安全

- 保持工作场地清洁和明亮。杂乱和黑暗的场地会引发事故。
- 不要在易爆环境，如有易燃液体、气体或粉尘的环境下操作电动工具。电动工具产生的火花会点燃粉尘或气体。
- 操作电动工具时，远离儿童和旁观者。注意力不集中会使你失去对工具的控制。

2) 电气安全

- 电动工具插头必须与插座相配。绝不能以任何方式改装插头。需接地的电动工具不能使用任何转换插头。未经改装的插头和相配的插座将降低电击风险。
- 避免人体接触接地表面，如管道、散热片和冰箱。如果你身体接触接地表面会增加电击风险。
- 不得将电动工具暴露在雨中或潮湿环境中。水进入电动工具将增加电击风险。
- 不得滥用电源线。绝不能用电源线搬运、拉动电动工具或拔出其插头。使电源线远离热源、油、锐边或运动部件。受损或缠绕的电源线会增加电击风险。
- 当在户外使用电动工具时，使用适合户外使用的延长线。适合户外使用的电线将降低电击风险。
- 如果无法避免在潮湿环境中操作电动工具，应使用带有剩余电流装置（RCD）保护的电源。RCD的使用可降低电击风险。

3) 人身安全

- 保持警觉，当操作电动工具时关注所从事的操作并保持清醒。当你感到疲倦，或在有药物、酒精或治疗反应时，不要操作电动工具。在操作电动工具时瞬间的疏忽会导致严重人身伤害。
- 使用个人防护设备。始终佩戴护目镜。诸如适当条件下使用防尘面具、防滑安全鞋、安全帽、听力防护等装置能减少人身伤害。
- 防止意外启动。在连接电源和/或电池包、拿起或搬运工具前确保开关处于关断位置。手指放在开关上搬运工具或开关处于接通时通电会导致危险。
- 在电动工具接通之前，拿掉所有调节钥匙或扳手。遗留在电动工具旋转零件上的扳手或钥匙会导致人身伤害。
- 请勿过分伸展。时刻注意立足点和身体平衡。这样能在意外情况下能更好地控制身体工具。
- 着装适当。不要穿宽松衣服或佩戴饰品。让你的头发和衣服远离运动部件。宽松衣服、佩饰或长发可能会卷入运动部件。

- 如果提供了与排屑、集尘设备连接用的装置，要确保其连接完好且使用得当。使用集尘装置可降低粉尘引起的危险。
- 不要因为频繁使用工具而产生的熟悉感而掉以轻心，忽视工具的安全准则。某个粗心的动作可能瞬间导致严重的伤害。

4) 电动工具使用和注意事项

- 切勿强制使用电动工具。根据用途使用合适的电动工具。选用合适的按照额定值设计的电动工具会使你工作更有效、更安全。
- 如果开关不能接通或关断电源，则不能使用该电动工具。不能通过开关来控制的电动工具是危险的且必须进行修理。
- 在进行任何调节、更换附件或贮存电动工具之前，必须从电源上拔掉插头和/或卸下电池包（如可拆卸）。这种防护性的安全措施降低了电动工具意外启动的风险。
- 将闲置不用的电动工具贮存在儿童所及范围之外，并且不允许不熟悉电动工具和不了解这些说明的人操作电动工具。电动工具在未经培训的使用者手中是危险的。
- 维护电动工具及其附件。检查运动部件是否调整到位或卡住，检查零件破损情况和影响电动工具运行的其他状况。如有损坏，应在使用前修理好电动工具。许多事故是由维护不良的电动工具引发的。
- 保持切削刀具锋利和清洁。维护良好地有锋利切削刃的刀具不易卡住而且容易控制。
- 按照使用说明书，并考虑作业条件和要进行的作业来选择电动工具、附件和工具的刀头等。将电动工具用于那些与其用途不符的操作可能会导致危险情况。
- 保持手柄和握持表面干燥、清洁，不得沾有油脂。在意外的情况下，湿滑的手柄不能保证握持的安全和对工具的控制。

5) 电池式工具使用和注意事项

- 仅使用生产者规定的充电器充电。将适用于某种电池包的充电器用到其他电池包时可能会发生着火危险。
- 仅使用配有专用电池包的电动工具。使用其他电池包可能会产生伤害和着火危险。
- 当电池包不用时，将它远离其他金属物体，例如回形针、硬币、钥匙、钉子、螺钉或其他小金属物体，以防电池包一端与另一端连接。电池包端部短路会引起燃烧或着火。
- 如滥用，液体可能会从电池包中溅出，应避免接触。如果意外碰到液体，用水冲洗。如果液体碰到了眼睛，还应寻求医疗帮助。从电池中溅出的液体可能会发生腐蚀或燃烧。
- 不要使用损坏或改装过的电池包或工具。损坏或改装过的电池包可能呈现无法预测的结果，导致着火、爆炸或伤害。
- 不要将电池包暴露于火或高温中。电池包暴露于火或高于130°C的高温中可能会发生爆炸。
- 请遵循所有充电说明，请勿在说明书中规定的温度范围以外的环境对电池包或工具充电。不当或在

指定范围以外的温度下充电,可能导致电池损坏并增加火灾风险。

6) 维修

- a) 让专业维修人员使用相同的备件维修电动工具。这将保证所维修的电动工具的安全。
- b) 切勿维修损坏的电池包。电池包只能由生产商或其授权的维修服务商进行维修。

其他具体安全规则

打磨、砂光、钢丝刷或磨料切割作业的常见安全警告

- a) 本电动工具的用途是作为研磨机、砂光机、钢丝刷或切割工具。请阅读本电动工具随附的所有安全警告、说明、图示和规定。未能遵照以下所列说明会导致电击、火灾和/或严重伤害。
- b) 不建议使用本电动工具进行钻洞机抛光等操作。若非本电动工具的预期操作,可能会产生危险并造成人身伤害。
- c) 请勿将本电动工具改装成工具制造商未专门设计和指定的操作方式。这种改装可能会导致工具失控并致人重伤。
- d) 切勿使用不是由工具制造商专门设计和指定的配件。因为该配件虽然可连接到您的电动工具上,但不能保证安全操作。
- e) 配件的额定速度必须至少等于电动工具上标记的最大速度。配件的运行速度超过其额定速度可能会导致断裂和飞散。
- f) 配件的外径和厚度必须在电动工具的额定容量内。尺寸不适合的配件无法得到充分保护或控制。
- g) 配件的安装尺寸必须符合电动工具安装硬件的尺寸。与电动工具安装硬件不匹配的配件将导致失去平衡、过度振动并可能造成失控。
- h) 请勿使用损坏的配件。每次使用前检查砂轮等配件是否有碎片和裂纹,衬垫是否有裂纹、撕裂或过度磨损,钢丝刷是否有钢丝松动或开裂。如果电动工具或配件掉落,请检查是否有损坏或重新安装一个完好无损的配件。检查和安装配件后,请您和旁观者远离旋转配件的平面,并以最大的空载速度运行电动工具一分钟。通常,受损的配件会在这个测试时间内破裂。
- i) 请佩戴个人防护装置。根据不同的应用,使用面罩、安全护目镜或安全眼镜。适当条件下,佩戴防尘面具、听力保护器、手套以及能够阻止小磨料或工件碎片的车间围裙。护目镜必须能够阻止各种操作产生的飞行碎片。防尘面具或呼吸器必须能够过滤操作中产生的颗粒。长时间暴露于高强度的噪音中可能会导致听力损失。
- j) 旁观者与工作区保持安全距离。任何进入工作区的人必须佩戴个人防护装置。工件碎片或破损的配件可能会飞溅,并在操作区域以外造成伤害。
- k) 在执行切割配件可能接触到隐藏电线或其自身电线的操作时,仅用绝缘抓手握住电动工具或其电源线。切割配件接触到“带电”的电线可能会使

电动工具的裸露金属部分“带电”,并导致操作人员触电。

- l) 将电线置于远离旋转配件的位置。如果失去控制,电线可能会被切断或卡住,您的手或手臂可能会被拉入旋转配件中。
- m) 在配件完全停止之前,切勿将电动工具放下。旋转的配件可能会抓住表面,导致电动工具不受控制。
- n) 当电动工具在身边时,切勿启动。意外接触到快速旋转的配件可能会勾住您的衣服,将配件拉到您的身体中。
- o) 定期清洁电动工具的通风口。电机的风扇会将灰尘吸入外壳内,过多的金属粉末堆积可能导致电气危险。
- p) 切勿在易燃材料附近操作电动工具。火花可能会点燃这些材料。
- q) 切勿使用需要液体冷却剂的配件。使用水或其他液体冷却剂可能导致触电或电击。

所有操作的详细安全说明

反弹和相关警告

反弹是指砂轮、背垫、刷子或任何其他配件被夹住或卡住时的突然反应。夹住或卡住会导致旋转的配件迅速停滞,因此又会导致不受控制的电动工具在连接点被迫向与配件旋转相反的方向转动。

例如,如果砂轮被工件卡住或夹住,进入夹点的砂轮边缘可能会挖进材料表面,导致砂轮爬出或踢出。根据砂轮在夹点处的运动方向,砂轮可能会脱离或远离操作员。在这种情况下,砂轮也可能断裂。

回弹是由于电动工具的误用和/或不正确的操作程序或条件造成的,可以通过采取以下适当的预防措施予以避免:

- a) 紧握电动工具,注意立足点和身体平衡,这样可以抵御反弹力。始终使用辅助手柄(如有),以最大限度地控制启动时的反弹或扭矩反应。如果采取了适当的预防措施,操作员就可控制扭矩反应或反弹力。
- b) 切勿将手放在旋转的配件附近。配件可能会反弹到您的手上。
- c) 如果发生反弹,请勿将身体放在电动工具移动的区域。反弹会使工具在卡住点向与砂轮的运动方向相反的方向旋转。
- d) 在角落、尖锐边缘等处工作时要特别小心。小心反弹和卡住的配件。角落、尖锐边缘或反弹均有可能卡住旋转的配件,导致失控或反弹。
- e) 切勿安装锯链、木雕刀片、外圈间隙大于10mm的分段式金刚石砂轮或齿形锯片。这种锯片会造成频繁反弹和失控。

针对研磨和切割操作的安全警告

- a) 仅使用针对电动工具推荐的砂轮类型以及为所选砂轮设计的特定防护罩。不适用于该电动工具的砂轮无法得到充分防护,也不安全。

- b) 中心凹陷砂轮的研磨表面必须安装在防护唇平面的下方。如果砂轮安装不当，导致突出防护唇平面，则无法得到充分防护。
- c) 防护罩必须牢固地连接到电动工具上，并放置在最安全的位置，这样砂轮对操作员的暴露程度最小。防护罩有助于防止操作员被破碎的砂轮碎片伤害，并防止意外接触砂轮和可能点燃衣物的火花。
- d) 切割轮仅可用于特定用途。例如：切勿用切割轮的侧面进行磨削。砂轮切割轮用于周边磨削，施加在切割轮上的侧向力可能会导致其破碎。
- e) 务必使用直径和形状与所选砂轮直径一致且完好无损的砂轮法兰。合适的砂轮法兰可支撑砂轮，从而降低砂轮破碎的可能性。切割轮的法兰可不同于磨轮法兰。
- f) 切勿使用大型电动工具上磨损的砂轮。用于大型电动工具的砂轮不适合高速度的小型工具，因为可能会发生爆裂。
- g) 在使用两用轮时，请务必根据所执行的应用使用正确的防护装置。不使用正确的防护装置可能会削弱防护效果，从而致人重伤。

切割操作的额外安全警告

- a) 切勿“卡住”砂轮或施加过大的压力。切勿试图切割过深。对砂轮过度施压会增加砂轮在切割过程中的负荷和扭曲或捆绑的可能性，并有可能出现反弹或砂轮断裂。
- b) 切勿将身体与旋转的砂轮保持齐平或位于旋转的砂轮之后。如果砂轮在操作点时远离身体，万一发生反弹，可能会把旋转的砂轮和电动工具直接推向你。
- c) 当砂轮被捆绑或因任何原因中断切割时，应关闭电动工具并保持电动工具不动，直到砂轮完全停止。当砂轮处于运动状态时，切勿试图将砂轮从切割中取出，否则可能会发生反弹。研究并采取纠正措施，从而消除砂轮捆绑的原因。
- d) 切勿在工件中重新开始切割操作。砂轮达到全速并小心地重新进入切割。如果电动工具在工件中重新启动，砂轮可能会捆绑、向上旋或反弹。
- e) 支撑面板或任何过大的工件，尽可能减少砂轮夹住和反弹的风险。大型工件在承受自身重量时容易凹陷。支架必须放置在靠近切割线的工件下方，并且靠近砂轮两侧的工件边缘。
- f) 在现有墙壁或其他盲区进行“袋式切割”时要特别小心。凸出的砂轮可能会切断煤气管或水管、电线或可能导致反弹的物体。
- g) 不要试图进行曲线切割。对砂轮过度施压会增加砂轮在切割过程中的负荷和扭曲或捆绑的可能性，并有可能出现反弹或砂轮断裂，从而致人重伤。

磨削操作的其他安全说明

- a) 使用大小合适的砂纸。选择砂纸时应遵循制造商的建议。尺寸远大于砂磨垫的砂纸可能会割伤人员，并可能导致砂磨盘绊住、撕裂或反弹。

钢丝刷操作的其他安全说明

- a) 请注意，即使在正常操作过程中，钢丝刷也会用出刷毛。请勿对钢丝刷施加过大的负荷，以免钢丝承受过大的应力。刷毛可轻松穿透轻薄的衣物和/或皮肤。
- b) 如需对钢丝刷使用防护罩，请勿让钢丝轮或刷子与防护罩发生任何干涉。作业和离心力可能导致钢丝轮或钢丝刷的直径扩大。

针对研磨机的额外安全规则

- a) 请勿在此工具上使用11型（杯形）砂轮。使用不合适的配件会导致人员受伤。
- b) 务必使用侧手柄。拧紧该手柄。应始终使用侧手柄来保持对工具的控制。

剩余风险

尽管遵守了相关的安全法规并采用了安全装备，某些剩余风险仍然是无法避免的。这些风险包括：

- 听力损伤。
- 飞溅颗粒造成的人身伤害风险。
- 使用时配件发热导致的灼伤风险。
- 长时间使用引起的人身伤害风险。

请妥善保管好这些说明

充电器

DEWALT充电器无需做出任何调整，专为简易操作而设计。

电气安全

电机只适用一种工作电压。请务必检查电池包的电压是否和铭牌上的电压一致。请务必检查充电器的电压是否和电源上的电压一致。



DEWALT充电器符合IEC60335双重绝缘要求，因此无需使用接地线。

如果电源线损坏，必须仅由DEWALT或授权的维修机构负责更换。

使用延长线

除非绝对必要，否则请勿使用延长线。使用适合您的充电器输入功率的合格延长线（请参阅**技术数据**）。最小的导线尺寸为1mm²；最大长度为30m。

使用电缆卷筒时，请务必拉出所有的电缆。

针对所有电池包充电器的重要安全说明

请妥善保管好这些说明：本手册包含重要的兼容电池包充电器安全和操作说明（请参阅**技术数据**）。

- 在使用充电器之前，请先阅读所有说明以及充电器、电池包和使用电池包的产品上的警告标记。



警告：电击危险。请勿让任何液体进入充电器，否则可能会导致触电。



警告：我们建议使用漏电保护额定电流为30毫安或以下的漏电保护装置。



小心：烧伤危险。为降低人身伤害风险，请仅使用DEWALT充电式电池包充电。使用其它类型的电池包可能会引起爆裂，并导致人身伤害和损害。



小心:应看管好儿童,以确保他们不将此设备当做玩具来玩。

注意:在某些情况下,当充电器的插头插入电源插座时,充电器内部裸露的充电接触点可能因为外来物件而短路。请勿让能导电的异物靠近充电器腔,这些外来物件包括但不限于钢棉、铝箔或任何金属颗粒的堆积物。充电器内没有电池包时,请断开充电器与电源的连接。清洗前,务必拔掉充电器

- 请勿试图使用本手册指定的充电器以外的其他任何充电器为电池包充电。充电器和电池包都是专门设计的,互相配合使用。
- 这些充电器不适合用于为DeWALT充电式电池充电以外的任何其他用途。否则,可能会导致火灾、触电或电击。
- 请勿将充电器暴露于雨中或雪中。
- 断开充电器连接时,应捏住插头将其拔下,而非通过拉拽电源线拔下插头。这将降低对插头和电线的损害风险。
- 确保电源线布置在不易踩踏、踢绊、拉扯或会受到损害或压力的位置。
- 除非绝对必要,否则请勿使用延长线。使用不正确的延长线可能导致火灾、触电或电击的风险。
- 请勿将任何物件放在充电器上面,或是把充电器放在可能会堵住通风槽的柔软表面,导致充电器的内部过热。请把充电器放置在远离任何热源的地方。充电器通过外壳顶端和底端的槽进行通风。
- 请勿使用电源线或插头已损坏的充电器,请立即更换这些充电器。
- 如果充电器受到强烈重击、掉落或出现其他损坏情况,请勿使用充电器。请将损坏的充电器送到授权服务中心。
- 请勿自行拆卸充电器。请将需要检修或修理的充电器送到授权服务中心。重装不正确可能导致触电、电击或火灾风险。
- 必须立即将已损坏的电源线交由制造商、服务代理或类似的合格人员进行更换以防止安全隐患。
- 清洁前,请先断开充电器和插座的连接,以降低触电风险。取出电池包不会降低此风险。
- 不得将两个充电器连接在一起。
- 充电器是为220-240V的标准家用电源而设计。请勿试图在任何其他电压下使用充电器。此规则不适用于车载充电器。

为电池充电(图B)

注意:有关开/关和闪烁模式,请参阅充电器上指示灯附近的标签。较旧的充电器可能有附加信息和/或可能没有黄色指示灯,只有一个红色指示灯。

1. 插入电池包前,先将充电器的插头插到相应的电源插座上。
2. 插入电池包并使其完全就位。左侧指示灯将持续闪烁红灯,表示充电过程已经开始。对于双阶段充电器,这表示第1阶段充电,在此阶段电池包已充满大部分电量。

3. 对于单阶段充电器,当左侧指示灯持续亮红,右侧指示灯不亮时,充电完成。对于双阶段充电器,当左侧指示灯持续亮红,右侧指示灯持续闪红,表示第2阶段充电,在此阶段电池包已充满电。当两个指示灯都持续亮红时,第2阶段充电完成。充电完成后,电池包可以取出使用,也可以留在充电器中。

充电器不会为故障电池包充电。充电器不亮可能表示充电器或电池包有问题。停止使用,并将充电器和电池包送至授权服务中心。

注意:在拆卸电池包时,部分充电器需要按住电池包释放按钮。



警告:只能在气温高于4°C和低于40°C的环境下为电池包充电。

单阶段充电器指示灯



双阶段充电器指示灯

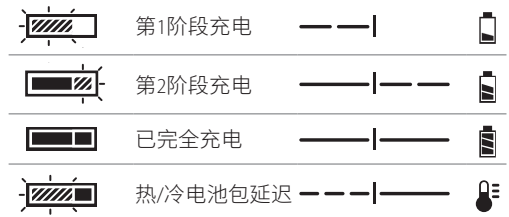

热/冷电池包延迟

当充电器检测到电池包过热或过冷时,它会自动启动热/冷电池包延迟模式,暂停充电,直到电池包达到适当的温度。然后,充电器会自动切换到电池包充电模式。此功能可确保电池包拥有最长的使用寿命。

冷电池包充电速度比热电池包充电速度慢。电池包在整个充电周期的充电速度都会较慢,即使电池包升温也不会恢复到最大速度。

某些充电器配备了内部风扇,用于冷却电池包。当电池包需要冷却时,该风扇会自动启动。如果风扇无法正常工作或通风槽被堵塞,切勿操作充电器。请勿让异物进入充电器的内部。

电子保护系统

XR锂离子电池包工具采用了电子保护系统设计,可让电池包免受过载、过热或过度放电之害。

如果电子保护系统处于运作状态,该工具将自动停止操作。如果发生这种情况,请将锂离子电池包放在充电器上,直至其完全充电。

壁挂式安装

这些充电器设计为可以安装在墙上,也可以直立在桌面或工作台上。如果安装在墙上,请确保充电器的位置可以连接到电源插座,并且远离墙角或其他可能妨碍空气流通的障碍物。将充电器背面作为在墙上安装螺丝的位置模板。使用至少25.4mm长、螺丝帽直径至少

7-9mm的石膏板螺丝(单独购买)牢牢固定充电器,将螺丝最大限度打入木材,预留约5.5mm露在墙外。将充电器背面的安装槽对准露出的螺丝,完全放置到位。

充电器清洁说明

警告:电击危险。清洁前,请将充电器从交流电源插座上拔下。可用布或非金属软刷清除充电器外部的污垢和油脂。请勿使用水或任何清洁剂。不得让任何液体渗入工具,不得让工具的任何部件浸在液体中

电池包

针对所有电池包的重要安全说明

在订购更换电池包时,请务必附上目录型号和电压。包装箱内的电池包并未完全充电。使用电池包和充电器之前,请阅读下列安全说明,然后遵循所述的充电程序。

请阅读所有说明

- 请勿在易爆环境,如有易燃液体、气体或粉尘的环境中充电或使用电池包。在充电器中插入或取出电池包时可能会点燃粉尘或气体。
- 不得强行将电池包放进充电器。请勿以任何方式改装电池包并将电池包插入不兼容的充电器,这种操作可能会导致电池包破裂,造成严重的人身伤害。
- 只使用DEWALT充电器为电池包充电。
- 请勿给电池包喷洒水或其他液体或将其浸泡在水或其他液体中。
- 请勿在温度可能降至4°C(39.2°F)的地方(如冬天户外的棚子或金属建筑物中)或达到或超过40°C(104°F)的地方(如夏天户外的棚子或金属建筑物中)存储或使用工具和电池包。
- 即使电池包严重受损或完全损坏,也请勿焚化电池包。电池包在火中会发生爆炸。锂离子电池包在燃烧时会释放有毒气体和物质。
- 如果电池包液体接触到皮肤,请立即以中性肥皂和清水冲洗接触的地方。如果电池包液体不慎进入眼睛,应睁开眼睛并用清水冲洗至少15分钟或直到刺激感消失。如果需要医疗救助,请告知医护人员。电池包电解质由液状有机碳酸盐和锂盐的混合物组成。
- 已打开电池包的内部物质可能导致呼吸道刺激。请保持空气流通。如果症状持续存在,请就医。

警告:烧伤危险。电池包液如果接触到火花或火焰可能会燃烧。

警告:不得以任何理由试图打开电池包。电池包外壳破裂或损坏时,请勿将电池包插入充电器。请勿挤压、掉落或损坏电池包。请勿使用受过强烈重击、掉落、碾压或以任何其它方式(如被钉子穿破、受到锤子的重击、踩踏)受损的电池包或充电器。否则可能会引起触电或电击。损坏的电池包应送回服务中心进行回收。

警告:火灾危险。请勿在存储或搬运电池包时让金属物品接触暴露的电池包两极。例如,请勿将电池包放在围裙、口袋、工具箱、产品套件盒、抽屉等可能与散钉、螺丝、钥匙等物品接触的地方。



小心:不使用时,应将工具侧放在稳定的表面上,以免造成绊倒或坠落的危险。一些带有大型电池包的工具可以直立在电池包上,但可能很容易被撞倒。

运输



警告:火灾危险。电池包运输途中,如果电池包两极意外接触导电材料,可能会引发火灾。运输电池包时,务必保护电池包两极,确保与可能接触电池包导致短路的材料良好绝缘。**注意:**不应将锂离子电池包放入托运行李中。

DEWALT电池包符合所有适用的行业和法律标准规定的运输规范,包括《联合国危险品运输建议规章范本》(UN Recommendations on the Transport of Dangerous Goods)、《国际航空运输协会(IATA)危险品规则》(International Air Transport Association (IATA) Dangerous Goods Regulations)、《国际海运危险品(IMDG)规则》(International Maritime Dangerous Goods (IMDG) Regulations)和《欧洲危险货物国际公路运输协定》(European Agreement Concerning The International Carriage of Dangerous Goods by Road (ADR)。锂离子电池包和电池包已遵循《联合国危险品运输建议规章范本手册》第38.3节关于测试和标准的说明通过测试。大多数情况下,发运DEWALT电池包不属于完全管制的9类危险品。通常情况下,只有当运输包含一个能量等级大于100瓦时(Wh)的锂离子电池包时,才需要作为完全管制的9类危险品发运。所有锂离子电池包外壳上均标注有瓦时等级。此外,由于法规比较复杂,无论瓦时等级是多少,DEWALT都不建议单独空运锂离子电池包。发运包含电池包的工作(组合套件)时,如果电池包的能量等级不大于100瓦时(Wh),则可以按计划空运。

无论发运是否纳入完全管制范围内,运输公司均有责任遵循最新法规中关于包装、标签/标记和单据的要求。本手册本节的信息是出于善意提供,且认为在编制文档时准确无误。不提供明示或暗示的担保。购买方负有确保其行为遵守适用法规的责任。

存放建议

1. 最好将电池包存放在阴凉、干燥、远离阳光直射、不会过热或过冷的地方。为了获得最佳的电池包性能和使用寿命,请您在不使用电池包时将其存储在室温下。
2. 长期存储时,建议将已完全充电的电池包从充电器取出,存储在阴凉、干燥的地方,以达到最佳效果。

注意:电池包不应在电池包已完全耗尽的状态下存放。使用电池包之前,必须重新为电池包充电。

充电器和电池包上的标签

除了在本手册中所使用的标志,充电器和电池包的标签还包括:



使用前请阅读使用手册。



如需了解充电时间详细信息,请参阅技术数据。



请勿使用导电物体戳刺。



请勿对损坏的电池包充电。



请勿将其暴露于水中。



应立即更换有缺陷的电线。



请只在4°C和40°C之间的温度下充电。



只能在室内使用。



弃置电池包时，请妥善处理以保护我们的环境。



只能用指定的DeWALT充电器给DeWALT电池包充电。使用DeWALT充电器为非DeWALT电池包充电可能会导致电池包爆炸或出现其他危险情况。



请勿焚化电池包。

电池包类型

以下工具使用54 (最大60) 伏特的电池包: DCG440。

更多信息, 请参考**技术数据**。

包装内的物品

包装中包含:

- 1台 角磨机 (包括管道盖)
- 1个 180 mm防护罩 (27型)
- 1个 侧面手柄
- 1个 侧手柄延长杆
- 1个 六角扳手
- 1个 充电器 (“N”或“NT”型中不含)
锂离子电池包 (“N”或“NT”型中不含)
- 1本 使用手册

注意: 电池包、充电器和工具箱没有随N型号附送。电池包和充电器没有随NT型号附送。B 型号包括Bluetooth® 电池包。

注意: Bluetooth®标志和徽标是Bluetooth®, SIG, Inc.的注册商标, DeWALT对这些标识的任何使用均经过许可。其他商标和商号均归各自所有者所有。

- 检查工具、部件或配件是否在运输过程中损坏。
- 操作前, 请抽空仔细阅读并**掌握本手册**。

工具上的标记

工具上印有下列图形:



使用前请阅读使用手册。



使用前请阅读使用手册。



请佩戴护目装备。



可见辐射。请勿盯着光看。

日期代码位置 (图F)

包含制造年份的日期码**30**, 打印在工具外壳上。

说明 (图A)

警告: 不得改装本电动工具或其任何部件, 否则可能会导致损坏或人身伤害。

- 1 触发开关
- 2 锁闭杆
- 3 主轴锁定按钮
- 4 主轴
- 5 辅助手柄
- 6 砂轮
- 7 无螺纹背衬法兰 (固定在主轴上)
- 8 锁紧法兰
- 9 27型防护罩⁷ (180 mm)
- 10 防护罩释放杆
- 11 电池包
- 12 电池包释放按钮
- 13 主手柄
- 14 侧手柄延长杆

设计用途

本DCG440无刷角磨机适用于专业的切割、打磨、磨削和钢丝刷应用。

请勿在潮湿环境中, 或在存在易燃液体或气体的环境中使用本工具。

本无刷角磨机是一种专业的电动工具。

请勿让儿童接触本工具。缺乏经验的操作员需要在监督下使用本工具。

- **儿童和体弱者。**在没有他人监督的情况下, 儿童或体弱者不适宜使用本产品。
- 本产品不适合体力、感官或智力不足以及缺乏经验、知识或技能的人员 (包括儿童) 使用, 除非一旁有能为他们的安全负责的监督人员。不得在无人监管的情况下让儿童接触本产品。

组装与调整

警告: 为降低严重的人身伤害风险, 在进行任何调整或取出/安装附件或配件之前, 请关闭工具并断开电池包连接。意外启动可能会导致人身伤害。

警告: 仅使用DeWALT电池包和充电器。

特征

E-Clutch™ 电子离合器

该装置配备有E-Clutch™ (电子离合器), 在负载过高时, 该装置将关闭, 以减少对用户的反作用力矩。需要循环开关 (打开和关闭) 才能重新启动工具。

回弹制动器™

当感应到挤压、停转或捆绑事件时，电子制动器会以最大的力啮合，以快速停止砂轮，减缓角磨机的运动，并关闭角磨机。需要循环开关（打开和关闭）才能重新启动工具。

断电™过载保护

在电机发生过载时，对电机的供电将会减少。如果电机持续过载，工具将关闭。需要循环开关（打开和关闭）才能重新启动工具。只要当前负载达到过载电流值（电机烧毁点），工具将断电。如果持续发生过载停机，在工具上施加较小的力/重量，直至工具能够在无过载啮合的情况下运行。

电子软启动

该功能可限制初始启动速度，使工具在1秒钟内逐渐达到全速。

插入或取出工具上的电池包(图J)

注意: 确保您的电池包 **11** 已经充满电。

要将电池包安装到工具手柄中

1. 将电池包 **11** 对准工具手柄内的轨道 (图B)。
2. 将电池包滑入手柄内，使其牢牢地固定在工具内，并确保您听到其锁定到位的声音。

从工具中取出电池包

1. 按下释放按钮 **12**，将电池包从工具握柄中稳稳地拉出。
2. 按本手册充电器部分所述将电池包插入充电器中。

电池包电量计(图C)

一些DEWALT电池包带有一个包含三个绿色LED指示灯的电量计，用于指示电池包内的剩余电量。

按下电量计按钮 **27** 不松开，即可启动电量计。三个绿色LED指示灯将以组合方式亮起，以指示剩余电量。当电池内的电量低于可用限制时，电量计将不会亮起，电池将需要重新充电。

注意: 电量计仅指示电池包的剩余电量。它并不表示该工具的功能，且将根据产品组件、温度和最终使用者的使用情况而有所不同。

固定辅助手柄(图D)

警告: 应始终使用该手柄，以完全控制工具。始终确保手柄拧紧。

将辅助手柄 **5** 拧紧到齿轮箱的一个螺纹安装孔中。

旋转齿轮箱(图E)

为了提高用户舒适度，齿轮箱将旋转90°进行切割操作。

1. 拆下将齿轮箱连接到电机外壳的四个角螺钉。
2. 在不将齿轮箱从电机外壳上分离的情况下，将齿轮箱盖旋转至所需位置。

注意: 如果齿轮箱和电机外壳分离超过3MM，必须由DEWALT服务中心对工具进行维修和重新组装。若不维修该工具，可能会导致电机和轴承故障。

3. 重新安装螺钉，将齿轮箱固定到电机外壳上。将螺钉拧紧至12.5 in.-lbs.扭矩。过紧会导致螺钉脱落。

防护罩

小心: 所有磨轮、切割轮、砂磨百叶轮、钢丝刷和钢丝轮都必须使用防护罩。只有在传统的砂磨盘进行砂磨时，可以在没有防护罩的情况下使用该工具。请参考图A，查看设备随附的防护罩。对于有些应用，可能需要从当地经销商或授权服务中心购买适用的防护罩。

注意: 边缘研磨和切割可使用专为该用途设计和指定的27型砂轮进行；6mm (1/4") 厚的砂轮适用于表面研磨，而较薄的27型砂轮需要检查制造商标签，以确定其是否可用于表面研磨或仅用于边缘研磨/切割。禁止进行表面研磨的任何砂轮必须使用1/41型防护罩。也可以使用1/41型砂轮和1/41型防护罩进行切割。

注意: 参见**配件表**，选择合适的防护罩/配件组合。

安装和拆卸防护罩(图F)

小心: 所有磨轮、切割轮、金刚石涂层轮、砂磨百叶轮、钢丝刷和钢丝轮都必须使用防护罩。只有在传统的砂磨盘进行砂磨时，可以在没有防护罩的情况下使用该工具。某些DEWALT型号配备了一个防护罩，用于凹陷中心砂轮(27型)和轮毂砂轮(27型)。砂轮片(27型和29型)和钢丝刷采用相同的防护罩设计。使用27型和29型以外的砂轮进行打磨和切割时，需要使用不随工具提供的其他配件防护罩。配件包中有这些配件防护罩的安装说明。

1. 打开防护罩释放杆 **10**。将防护罩上的凸耳 **17** 与齿轮箱上的槽 **15** 对准。
2. 向下推动防护罩，直到防护罩上的凸耳啮合并在齿轮箱轮毂上的凹槽中自由旋转。
3. 打开防护罩搭扣，将防护罩 **9** 旋转到所需的工作位置。防护罩主体应该位于主轴和操作者之间，最大限度地保护操作者安全。
4. 关闭防护罩搭扣，将防护罩固定在齿轮箱上。搭扣关闭时，用手应该无法旋转防护罩。不要在防护罩松动或夹紧杆处于打开位置时操作角磨机。
5. 要卸下防护罩，请打开防护罩搭扣，旋转防护罩使箭头对齐，然后拉起防护罩。

注意: 防护罩在出厂时已根据齿轮箱的直径进行了预调。如果使用一段时间后，防护罩变得松动，可在夹紧杆处于关闭位置时拧紧调节螺钉 **16**。

小心: 不要在夹紧杆处于打开位置时拧紧调节螺钉。否则可能会对防护罩或安装轮毂造成难以察觉的损坏。

小心: 如果无法通过调整夹钳拧紧防护罩，请勿使用工具，并将工具和防护罩送至服务中心进行维修或更换。

法兰和砂轮

警告: 为降低严重人身伤害的风险，请先关闭工具并拆除电池包，然后再进行任何调节或拆除/安装配件或附件。意外启动工具可能会造成伤害。

安装无毂车轮(图G)

警告: 法兰和/或砂轮未正确就位会导致严重的人身伤害(或造成工具或砂轮损坏)。

小心:中心凹陷的27/42型砂轮和1/41型切割轮必须使用随附的法兰。更多信息见**配件表**。

警告:使用研磨切割轮或金刚石涂层切割轮时,需要使用封闭式双面切割轮防护罩。

警告:使用损坏的法兰或防护罩或未使用正确的法兰和防护罩会因砂轮破损和砂轮接触而导致人身伤害。更多信息见**配件表**。

1. 将工具放在工作台上,盖好防护罩。
2. 将砂轮**6**靠在背衬法兰**7**上,使砂轮在背衬法兰的凸起中心(导孔)上居中。
3. 按下主轴锁定按钮,六角凹陷朝向远离砂轮的方向,将螺纹锁紧法兰**8**拧在主轴上,使凸耳啮合主轴上的两个槽。
4. 按下主轴锁定按钮的同时,用六角扳手拧紧螺纹锁紧法兰**8**。
5. 如需拆下砂轮,按下主轴锁定按钮并松开螺纹锁紧法兰。

安装砂磨衬垫(图A、H)

注意:不要求将防护罩与使用衬垫的砂磨盘(通常称为纤维树脂盘)结合使用。由于这些配件不需要防护罩,使用防护罩时防护罩可能会也可能不会正确吻合。

警告:夹紧螺母和/或衬垫未正确就位会导致严重的人身伤害(或造成工具或砂轮损坏)。

警告:砂磨应用完成后,必须为砂轮、切割轮、砂磨百叶轮、钢丝刷或钢丝轮应用重新安装合适的防护罩。

1. 将衬垫**19**放在主轴上或用螺丝适当固定到主轴上。
2. 将砂磨盘**18**放在衬垫**19**上。
3. 按下主轴锁定按钮**3**的同时,将砂磨夹紧螺母**23**拧在主轴上,将夹紧螺母上的凸起轮毂导向打磨盘和衬垫的中心。
4. 用手拧紧夹紧螺母。然后在转动砂磨盘的同时按下主轴锁定按钮,直到砂磨盘和夹紧螺母紧密贴合。
5. 如需拆下砂轮,按住主轴锁定按钮,抓住并转动衬垫和砂磨垫。

操作前

- 安装防护罩和适用的磨盘或砂轮。请勿使用过度磨损的磨盘或砂轮。
- 确保螺纹锁紧法兰安装正确。遵循**配件表**中提供的说明。
- 确保磨盘或砂轮按照配件和工具上的箭头方向旋转。
- 请勿使用损坏的配件。每次使用前检查砂轮等配件是否有碎片和裂纹,衬垫是否有裂纹、撕裂或过度磨损,钢丝刷是否有钢丝松动或开裂。如果电动工具或配件掉落,请检查是否有损坏或重新安装一个完好无损的配件。检查和安装配件后,请您和旁观者远离旋转配件的平面,并以最大的空载速度运行电动工具一分钟。通常,受损的配件会在这个测试时间内破裂。

操作

使用说明

警告:务必遵守安全指示和适用法规。

警告:为降低严重的人身伤害风险,在进行任何调整或取出/安装附件或配件之前,请关闭工具并断开电池包连接。意外启动可能会导致人身伤害。

正确的双手放置位(图K)

警告:为了减低严重人身伤害的风险,请务必如图示那样正确放置双手。

警告:为了减低造成严重人身伤害的风险,预期有突然反作用力时**务必**握紧。

正确的手部位置是一只手放在主手柄**13**上,另一只手放在辅助手柄**5**上,如图K所示。

触发开关和锁定杆(图A)

警告:使用工具前检查辅助手柄是否拧紧。

警告:握紧工具的辅助手柄和主手柄,在启动和使用过程中保持对工具的控制,直到砂轮或配件停止旋转。放下工具前确保砂轮完全停止。

1. 要打开工具,将锁定杆**2**推向工具背面,然后按下触发开关**1**。按下开关时,工具将运行。
2. 松开开关后,工具将关闭。

警告:在工具接触工作面之前,让工具达到全速。关闭工具前,从工作面提起工具。

注意:本工具无法将开关锁定在ON位置,因此切勿以任何其他方式使其锁定在ON位置。

主轴锁定(图A)

主轴锁定按钮**3**用于在安装或拆卸砂轮时防止主轴旋转。只有当工具已关闭、电池已取出并完全停止时,才能操作主轴锁。

注意:为了降低损坏工具的风险,请勿在工具运行时使用主轴锁。这会导致工具损坏,而且连接的配件可能脱落,从而可能造成人身伤害。

如需锁定,按下主轴锁定按钮并旋转主轴,直到无法继续旋转主轴。

表面磨削、砂磨和用钢丝刷清理(图L)

小心:务必按照本手册中的说明使用正确的防护罩。

如需在工件表面上执行工作:

1. 在工具接触工作面之前,让工具达到全速。
2. 对工作面施加尽可能小的压力,使工具高速运转。当工具高速运转时,材料去除率最大。
3. 让工具和工作面呈适当的角度。根据特定功能参考图表。

功能	角度 \angle
磨削	20°-30°
用百叶轮打磨	5°-10°

功能	角度 \angle
用衬垫打磨	5°-15°
用钢丝刷清理	5°-10°

4. 使砂轮边缘和工作面之间保持接触。

- 如果进行磨削，通过百叶轮打磨或钢丝刷清理连续地向前和向后移动工具，以避免擦伤工作面。
- 如果用衬垫砂磨，请沿直线不断移动工具，以防止工作面烧损和打转。

注意：如果让工具停留在工作面上而不移动，则会损坏工件。

5. 关闭工具前，将工具从工作面上取下。放下工具前，让工具停止旋转。

！ 小心：在边缘作业时格外小心，因为研磨机可能会突然剧烈晃动。

处理涂漆工件时应采取的预防措施

1. 由于难以控制脏污的灰尘，因此不建议使用砂纸打磨或钢丝刷来处理含铅涂料。铅中毒对儿童和孕妇的危害最大。
2. 由于不进行化学分析很难确定油漆是否含铅，因此我们建议在砂磨任何油漆时采取以下预防措施：

人身安全

1. 在所有清理工作完成之前，儿童或孕妇不得进入正在进行油漆砂磨或钢丝刷清理的工作区域。
2. 所有进入工作区域的人员都应佩戴防尘口罩或呼吸器。过滤器应每天更换，或在佩戴者呼吸困难时更换。

注意：只能使用适合处理含铅油漆粉尘和烟雾的防尘面具。普通喷漆面具无法提供这种保护。请咨询您当地的硬件经销商，以获取经N.I.O.S.H.认可的合适面具。

3. 不得在工作区域饮食或吸烟，以防止吸入被污染的油漆颗粒。工作人员在饮食或吸烟之前应该进行洗手和清理。不应将食品、饮料或吸烟物品留在工作区，否则会落满灰尘。

环境安全

1. 应以尽量减少灰尘的方式清除油漆。
2. 发生脱漆的区域应该用厚度4密耳的塑料薄膜密封。
3. 砂磨时应减少工作区域外油漆粉尘的痕迹。

清洁和处理

1. 在砂磨项目期间，应对工作区域的所有表面每天进行吸尘和彻底清洁。真空滤袋应经常更换。
2. 应将塑料抹布收集起来，与任何灰尘碎片或其他清除碎片一同处理。应将其放在密封的垃圾箱中，并通过常规的垃圾收集程序进行处理。清理过程中，儿童和孕妇应远离直接工作区域。
3. 儿童使用的所有玩具、可洗家具和用具在再次使用前应彻底清洗。

边缘磨削和切割(图M)

！ 警告：切勿将边缘磨削/切割砂轮用于表面磨削，因为该工具并非设计用于表面磨削时所遇到的侧压力。可能会导致砂轮破损和损伤。



小心：在使用砂轮进行边缘磨削和切割时，如果使用工具的同时砂轮发生弯曲或扭曲，可能会断裂或反弹。在所有磨削/切割操作中，防护罩的开口侧必须远离操作者。

注意：如果要使用27型砂轮进行边缘磨削/切割，必须仅限于浅切割和开槽—新砂轮的深度小于13 MM (1/2")。随着砂轮磨损，应减少切割/开槽的深度，使其等于砂轮半径的减少量。更多信息见**配件表**。使用41型砂轮进行边缘磨削/切割时，需要使用1型防护罩。

1. 在工具接触工作面之前，让工具达到全速。
2. 对工作面施加尽可能小的压力，使工具高速运转。当工具高速运转时，磨削/切削速率最大。
3. 请调整您自己的位置，使砂轮的开口背面背向你。
4. 开始切割并在工件上形成切口后，请勿改变切割的角度。改变角度会导致砂轮弯曲，并可能导致砂轮断裂。边缘磨削砂轮无法承受弯曲造成的侧压力。
5. 关闭工具前，将工具从工作面上取下。放下工具前，让工具停止旋转。

维护

您的电动工具设计精良，可以长期使用，仅需极少维护。若要持续令人满意的工作效果，则需对工具进行适当的保养和定期清洁。



警告：为降低严重的人身伤害风险，在进行任何调整或取出/安装附件或配件之前，请关闭工具并断开电池包连接。意外启动可能会导致人身伤害。

充电器和电池包无法维修。



润滑

本电动工具无需另行润滑。



清洁



警告：一旦看到通风口及其周围积聚了尘屑，请用干燥的空气将灰尘和尘屑从主机外壳内吹出。执行此过程时，需戴上经认可的护目装备和防尘面具。



警告：不得使用溶剂或其它刺激性化学制品来清洁工具的非金属部件。这些化学物质可能会削弱这些部位使用的材料。请用布蘸温和的肥皂水擦拭。不得让任何液体渗入工具，不得让工具的任何部件浸在液体中

可选配件



警告：由于除DEWALT提供的配件外，其他配件没有经过本产品的测试，因此将这些配件与本工具一起使用可能会有危险。为了减少受伤的风险，本产品仅可使用DEWALT推荐的配件。

请向您的经销商咨询更多关于合适配件的信息。

该工具可容纳直径180 mm (7")x厚6 mm (1/4")的砂轮或切割轮。一定要选择适用于角磨机配件的防护罩、背垫和法兰。有关选择正确附件的信息,请参见**配件表**。

包装中的“联系中心定位器”宣传单页,通过热线电话、网站或社交媒体联系我们,找到距离您最近的DeWALT服务中心。



警告: 配件的额定速度必须至少达到工具警告标签上的建议速度。砂轮和其他配件的运行速度超过其额定配件速度时,可能会飞散并致人受伤。带螺纹的配件必须使用M14轮毂。每个无螺纹配件都必须有一个22毫米(7/8")的轴孔。如果没有,则可能是为圆锯设计的。只能使用本手册**配件表**中显示的附件。配件额定值必须始终高于工具铭牌上显示的工具速度。



警告: 小心处理和存放所有砂轮,以防止热冲击、高温、机械故障等问题损坏砂轮。请将其存放在干燥、受保护的区域,避免湿度过高、温度过低或温度骤变。

Tool Connect™芯片(图N)



警告: 为降低严重人身伤害的风险,在进行任何调整或拆装附件或配件之前,请先关闭工具并断开电源,然后锁上工具,取下电池包。意外启动可能会导致人身伤害。

您的工具已经装有Tool Connect™芯片,同时也预留了安装Tool Connect™芯片的位置。

在您的智能设备(例如智能手机或平板电脑)中,Tool Connect™芯片是可选应用,能够连接设备,使用移动应用,实现库存管理的功能。

请参见**Tool Connect™芯片说明书**,获取更多信息。

安装Tool Connect™芯片

1. 拆除用于将Tool Connect™芯片保护盖**21**安装到工具上的固定螺钉**26**。
2. 拆除保护盖,将Tool Connect™芯片插入空槽**22**中。
3. 请确保Tool Connect™芯片与外壳齐平。用固定螺钉来固定保护盖,并拧紧螺钉。
4. 请参见**Tool Connect™芯片说明书**,获取更多指导。

保护环境



分类回收。由此符号标记的产品和电池包不得与普通家庭垃圾一起处理。

产品和电池包包含可恢复或回收的材料,从而降低对原材料的需求。请根据当地规定回收电子产品和电池包。要获得更多信息,请参看www.2helpU.com。

充电式电池包

本电池包使用寿命长,不能提供顺利完成工作所需的电力时,必须进行充电。电池包技术寿命结束时,请妥善处理以保护环境:



- 耗尽电池包的电力,然后将其从工具上拆下。
- 锂离子电池是可回收的。请将它们送往您的经销商处或当地的回收站。回收的电池包将被妥善循环使用或处理。





售后服务和维修



DEWALT维修中心拥有经过培训的人员,能够为顾客提供充分、可靠的产品服务。如果您通过未获授权的维修中心进行维修,我们不会承担任何责任。您可以参见产品

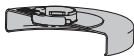

DCG440配件表



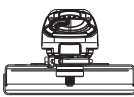

适用于DCG440的轮片	
1/T1类	
27/T27类	
不适用于DCG440的轮片	
11/T11类	

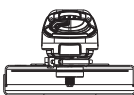
27型中心凹陷砂轮		
27型防护罩 (浅)		
27型中心凹陷 砂轮		
锁紧法兰		

无轮毂百叶轮		
27型防护罩 (浅)		
无轮毂百叶轮		
锁紧法兰		

1/41型切割轮		
1/41型防护罩**		
1/41型研磨切 割轮		
锁紧法兰		

金刚石切割轮		
1/41型防护罩**		
金刚石切割轮		
锁紧法兰		

砂磨盘		
橡胶衬垫**		
砂磨盘		
砂磨夹紧螺母 (包括橡胶 衬垫**)		
轮毂扳手		
轮毂扳手**		

! 1/41型防护罩用于1/41型切割轮和27型切割轮。使用27型和29型以外的砂轮进行磨削时，需要使用不同的配件防护罩。始终使用小型适当防护罩，以免接触到配件。

**注意：可从当地经销商或授权服务中心付费购买。

制 造 商： 百得美国公司
地 址： 701 East Joppa Rd.TW050 MD21286,Towson,美国
产 地： 江苏苏州

